

INFAB



FEATURED PRODUCT
CATALOG

PEACE OF MIND

In Radiation Protection

INFAB is at the forefront of shielding healthcare professionals from the hazards of ionizing scatter radiation, offering an unparalleled range of protective gear. We're dedicated to ensuring that healthcare workers can perform their duties with the confidence and security that only comes from utilizing our rigorously tested and meticulously designed products. Our mission is clear: to equip medical professionals with the protection they need, thereby delivering peace of mind through reliability and superior craftsmanship in every product we offer.





Empowering Customers with Knowledge

INFAB is unwavering in its commitment to empowering our customers with detailed insights into the advanced materials and technologies that enhance the safety of our radiation protective gear. Understanding these innovations is essential for informed decision-making and for comprehending the level of protection provided.

Expert Support for Radiation Protection

Connect with our dedicated global team of radiation protection experts for personalized support and guidance. With years of industry experience, our specialists offer friendly and efficient support, ensuring that all your questions are addressed with the expertise and attention you deserve.



REVOLUTION APRONS

Utilizing state-of-the-art technology, our aprons are crafted to provide optimal protection from radiation, with a special emphasis on long-lasting comfort. Each apron within our Revolution line is thoughtfully designed for exceptional weight distribution, reducing strain and enhancing wearability during prolonged procedures. Beyond functional excellence, personalize your apron with logos or monograms to embody your professional identity.

PARTIAL OVERLAP:

Full protection in each panel and double protection where the panels overlap in the front.

COLOR BLOCK DESIGN:

Exclusive Revolution color combination. Customization options available.

REVOLUTION FABRIC:

Lightweight, water, abrasion, flame, and bacterial resistant.

SMART TRACK:

Web-based garment inspection tracking system.

103

**Revolution
Vest & Skirt**

505 Navy - Black Block



903

**Revolution
Reverse
Vest & Skirt**

512 Ducks Green -
Black Block



All aprons are available in KIARMOR Bi-Layer Lead-Free and Lightweight Lead. KIARMOR passes all three universally recognized testing procedures: ASTM F3094-14, IEC 61331-1:2014, DIN 6857-1.





L103

Revolution Lumbar Vest & Skirt

514 Jewelry Box Blue - Black Block



203

Revolution Full Wrap Black Belt

506 Teal - Black Block



303

Revolution Front

608 Black - Sky Blue Block



403

Revolution Elastic Back Front

513 Tide Red - Black Block



503

Revolution Front Black Belt

504 Pink - Black Block



603

Revolution Full Wrap Elastic Back

602 Black - Fuchsia Block



703

Revolution Full Overlap Lumbar Vest & Skirt

510 Purple - Black Block



803

Revolution Black Belt Wrap

515 Orange - Black Block

Revolution Base



BL103
Vest & Skirt
Lumbar Belt



B103
Vest & Skirt



B203
Full Wrap Apron -
Lumbar Belt



B303
Front Panel Apron



B403
Front Panel Apron -
Elastic Back



B503
Front Panel Apron -
Lumbar Belt



B603
Full Wrap Apron -
Elastic Back

Revolution Base offers all the comfort and protection of our premium Revolution line, but with our classic nylon colors and patterns. Revolution Base does not include Revolution Fabric, Color-Blocking or Cool-Wear.

Size	Female XS-2XL Male S-2XL
Fabric	Nylon
Protection	.25mm LE, .35mm LE, and .50mm LE
Core	Lightweight Lead or KIARMOR Lead-Free
Color	Classic solid colors & patterns



REV-TC
Thyroid Collar

Hook and Loop or
Buckle Closure
Closure

NST
Thyroid Collar
without Binding

Hook and Loop, Buckle
or Magnet Closure

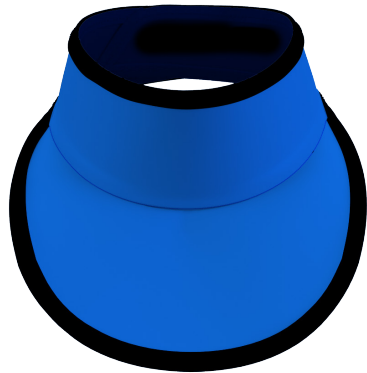

SVT
Visor Style
Thyroid Collar

Hook and Loop or
Buckle Closure

TCV
Thyroid Collar
with Binding

Hook and Loop, Buckle
or Magnet Closure

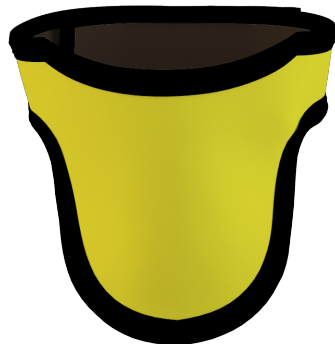

THYROID COLLARS

INFAB offers thyroid collars to protect against scatter radiation. Our collars can be attached to lead aprons. Choose from buckle, hook and loop, or magnetic closures. Personalize with colors, patterns, monograms and logos.

MTC
Magnetic
Thyroid Collar
Magnet Closure



CLASSIC APRONS

The Infab Classic line features a selection of radiation protection aprons in an array of colors. Crafted from lightweight nylon, they can be personalized with your choice of colors, logos, and monograms for a unique touch.

STYLES:

Choose from a variety of colors and patterns. View at: Infabcorp.com/colors

MAKE IT YOUR OWN:

Fully customizable with colors, patterns, logos, and monograms.

NYLON FABRIC:

Standard lightweight nylon fabric.

SMART TRACK:

Web-based garment inspection tracking system.



VAS

Vest & Skirt

SH-8 Fish Bones



All aprons are available in KIARMOR Bi-Layer Lead-Free and Lightweight Lead. KIARMOR passes all three universally recognized testing procedures: ASTM F3094-14, IEC 61331-1:2014, DIN 6857-1.





LSW
Full Overlap
with Lumbar Belt
SH-29 Planets



FCW
Full Coat Wrap
LT221-23
Buzzing Bees



WBT
Wide Belt
SH-12 Unicorn



SDA
Surgery Drop
Away
SH-15 Flamingo



LSF
Black Belt Front
SH-13 Hawaiian Flowers



RVAS
Reverse Vest
& Skirt
SH-23 Art Deco



AWC
Weight Reliever
LT221-16 Lovely Lemons



EBA
Elastic Black
SH-52 Mixed Dogs

LIGHTNING **APRONS**

Quick Ship Aprons

The Lightning Series includes Vest & Skirt, Full Wrap, and Front Protection aprons, all equipped with SmartTrack technology for enhanced tracking. Available in both KIARMOR Bilayer lead-free and lightweight lead options, they come in a variety of sizes and colors, ensuring optimal safety, flexibility, and comfort.



UFW
Lightning Full Wrap
Purple



UVS
Lightning Vest & Skirt
Teal



UFW
Lightning Front Protection
Charcoal





SMART TRACK

SMARTTRACK.INFACORP.COM

Track & Document Lead Apron Inspections



INCLUDED ON ALL INFAB GARMENTS

Manage all of your lead aprons in one place with Smart Track, the completely FREE and secure web-based garment tracking system.

SMARTTRACK.INFACORP.COM

DOWNLOAD THE APP TO SCAN



1. Download the free app.
2. Create your Smart Track account.
3. Add your garments.
4. Document your inspections.
5. Set inspection reminders.
6. Export and download reports.



TRACK ANY GARMENT

Use your existing garment IDs or add Smart Track Retrofit Tags to any apron to get started. Smart Track Retrofit Tags feature unique IDs that can be scanned with the Smart Track App or any 2D scanner.



Annual Inspection Stickers



SMART TRACK Scanner



SMART TRACK 2D bar code retrofit tags with permanent security-style backing

ACCESSORIES

Gloves, Cleaners, Disposables, Patient Protection and More

INFAB's accessory line includes radiation protection gloves, effective cleaning solutions, and specialized covers and curtains, alongside a selection of dental and patient safety aprons and shields for comprehensive radiographic care.



MAXI-FLEX MITTENS

18 Colors Available



GLOVES

INFAB offers radiation protection gloves in various colors, styles, and lead equivalencies.

INFAB Radiation Protection Surgical Gloves

Lead-free, latex-free,
powder-free.



REVOLUTION MAXI-FLEX 5 FINGER LEAD GLOVES

COLOR: Black, Red,
Blue (shown) and
15 additional colors

REVOLUTION GLOVES

Latex-free, tactile precision.



XGUARD® Gloves

Tactile sensitivity, powder-free.



Neoprene Gloves

Lead-free, latex-free, powder-free.

CLEANERS

INFAB's Scrubbles apron cleaner removes barium, blood, and other radiology stains, leaving behind a clean citrus scent. Clorox Healthcare products are also available for cleaning and disinfecting in healthcare facilities.



HEALTHCARE®

Infab is proud to be a global cleaning solutions partner with Clorox.

- No harsh chemical odor or fumes
- No fragrance added
- Nonflammable, unlike quaternary ammonium-alcohol-based wipes
- No volatile organic compounds (VOCs)



CASSETTE COVERS

Our cassette covers offer robust contamination defense throughout the radiographic process, safeguarding film, imaging plates, and intensifying screens.

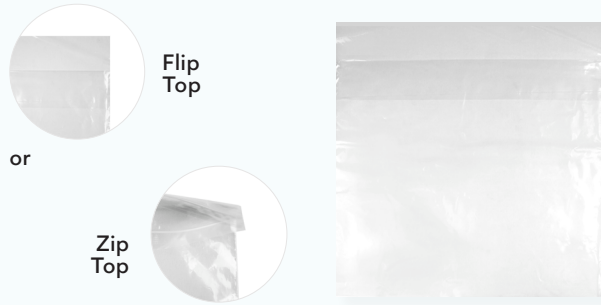

Available in a Variety of Sizes



C-ARM DRAPES

C-Arm drapes provide a sterile barrier to maintain a clean field during fluoroscopic procedures, ensuring both equipment protection and patient safety.



CURTAINS

INFAB's lead curtains are tailored to your preferences, available in an array of sizes, colors, and fabrics, with lead equivalency options of 0.25 mm, 0.35 mm, and 0.50 mm to meet varying protective needs.



Any Infab Classic Nylon Color



Straight Track



Curved Track

DENTAL

Our dental aprons protect patients and staff members with colorful designs and the ability to customize with patterns and logos.



DTL-ADULT
Dental Apron



DTL-PANO
Pano Cape
Dental Apron

PATIENT

Our eye, thyroid, ovarian, and gonad protective shields ensure optimal patient care during medical procedures.



PP-ES
Disposable Eye
Shields



PP-TS
Disposable Thyroid
Shield



HSV
Half Apron



683400
Patient Protection Set



684120
Ovarian Shields



PGS
Gonad Shields

GLASSES

Style + Protection

Our lead glasses are engineered to meet the industry standard of 0.75mm lead equivalency for the protective glass, providing you with the highest level of protection against harmful radiation beams.

These stylish and modern pieces are designed to withstand the daily rigors of your work and keep you safe. We provide you with the best quality radiation protection eyewear for your daily needs.



 **NIKE BRAZEN**



GUCCI

Frames update frequently. Check for availability.





 **Oakley Crosslink Zero**



GUCCI GG0343-007



GUCCI GC0758-003



 **NIKE PREMIER**



 **NIKE 7118**



 **NIKE MAVERICK RGE**



FITOVER MX



MAXX 30



EVO

BARRIERS

Mobility & Protection

Ensure comprehensive protection from head to toe with our range of durable mobile barriers. Choose between acrylic or lead shields. Customizable options include color, metal type, height, width, and window configurations to suit your needs. INFAB's mobile barriers offer convenient mobility and easy-to-clean features, simplifying your workflow and enhancing safety.



EVO-460
Flat-Pack Barrier





683461
Tilted Mobile
Barrier



076993
Technician
Protection
Mobile Screen
Adjustable from 44" to 73"



REV-SPMC
Revolution Solid
Panel Mobile Curtain



683495
Adjustable Height
Wraparound Barrier



REV-PMC
Revolution Mobile
Curtain
Adjustable from 43.5" to 66"

BARRIERS

*All Glass comes in Lead or Acrylic (-AC)



683492
Large Window
Mobile Barrier

SIZE: 80¼" H x 40½" W x 25"D
WINDOW: 72" H x 36" W

683476
X-Tall Mobile
Barrier

SIZE: 78¼" H x 40½" W x 25"D
WINDOW: 60" H x 36" W

683488
X-Wide Mobile
Barrier

SIZE: 74½" H x 76½" W x 25"D
WINDOW: 36" H x 72" W

683473
Mid-Tall Mobile
Barrier

SIZE: 74½" H x 34½" W x 25"D
WINDOW: 60" H x 30" W

683482
Wide Mobile
Barrier

SIZE: 72" H x 52½" W x 25"D
WINDOW: 36" H x 48" W



683465
Small Window
Mobile Barrier

SIZE: 72¼" H x 52½" W x 25"D
WINDOW: 12" H x 12" W

683468
Medium Window
Mobile Barrier

SIZE: 74" H x 52½" W x 25"D
WINDOW: 12" H x 24" W

683460
Standard Mobile
Barrier

SIZE: 72" H x 34½" W x 25"D
WINDOW: 24" H x 30" W

683484
Regular Mobile
Barrier

SIZE: 64½" H x 40½" W x 25"D
WINDOW: 24" H x 36" W

683458
"Shorty" Mobile
Barrier

SIZE: 45" H x 34½" W x 25"D
WINDOW: 24" H x 30" W

LOCKERS

Security + Protection

Our Revolution Lockers combine protection and security for your garments. They include a passcode encrypted keypad and durable frame for secure storage.



REV-LOCKER-20
Revolution
20 Hanger Mobile
Apron Locker



REVOLUTION MOBILE APRON LOCKERS



REV-LOCKER-5
Revolution
5 Hanger Mobile
Apron Locker



REV-LOCKER-10
Revolution
10 Hanger Mobile
Apron Locker



Revolution Lockers are securely locked with a battery-operated passcode encrypted keypad that allows you to set up to three administrative codes.

RACKS

Save Space + Increase Apron Life

INFAB offers apron racks for storing lead aprons used in healthcare facilities. These racks are sturdy and can hold multiple aprons, ensuring easy access for staff. They come in a variety of sizes and designs.



REV-MRK-10
Revolution 10 Arm
Mobile Apron Rack



683435
10 Hanger Mobile
Apron Valet



683438
20 Hanger Mobile
Apron Valet



683419
Mini Mobile Apron
Rack with Hangers

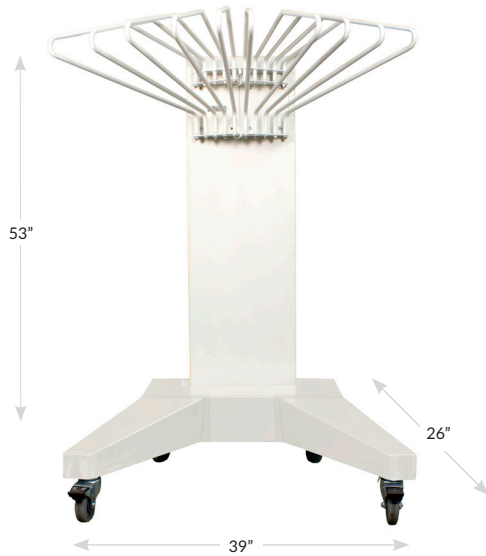

683407
Deluxe Mobile
Apron Rack



683426
5 Arm Budget Saver
Mobile Apron Rack



683427
10 Arm Budget Saver
Mobile Apron Rack



SCATTER ARMOR

Radiation Protection Shields & Drapes for Interventional Procedures

Prolonged low-dose exposure to scatter radiation can increase cancer risk for healthcare professionals. Scatter Armor shields and drapes reduce this risk by minimizing overall exposure.

“The scattered radiation from the patient comprises the main source of radiation dose to staff.”

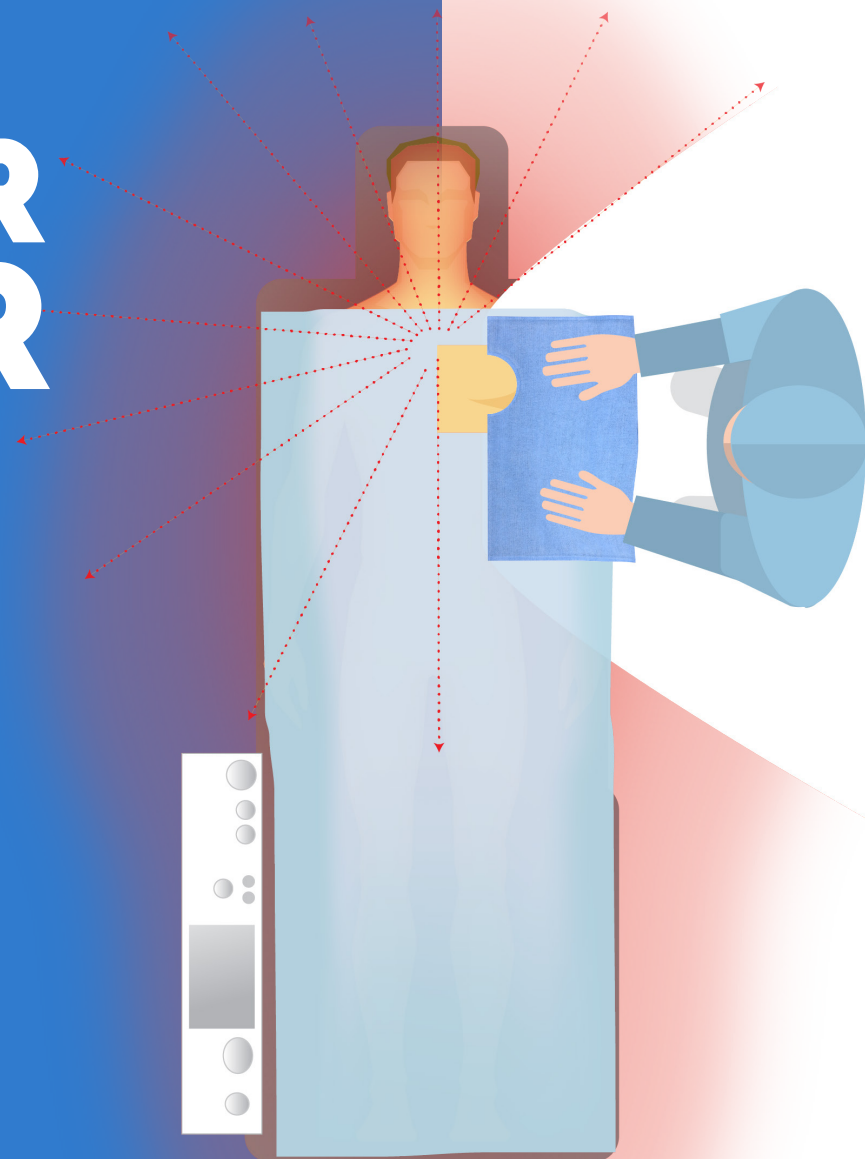

Scatter Protection

Scatter Armor Shields provide scatter radiation protection for radial and many other types of procedures. KIARMOR Bi-Layer is the most protective core material against scatter radiation.

SA-MPS Scatter Armor Multipurpose Shield

Transradial Access: Left and Right Radial, Shunt, Biliary Drainage, Spinal, Fibroid Embolization.

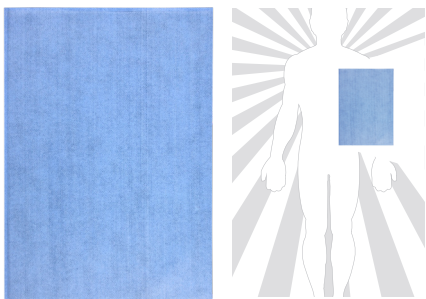

Absorbent

Scatter Armor Shields utilize the highest absorbency covering material in the industry, critical in heavy fluid situations.

SA-MPF Scatter Armor Multipurpose Shield with Fenestration

Needle Biopsy or Puncture Procedures.

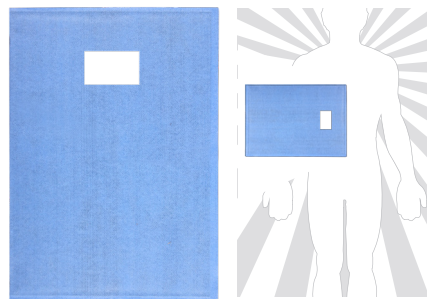

Flexible

Scatter Armor Shields easily mold to the patients body for ease of use and maximum protection.

SA-EPS Scatter Armor EP Shield

Subclavian Access: Bi-Ventricular Pacemaker Implants, ICS procedures, and Bi-Ventricular Pacing.

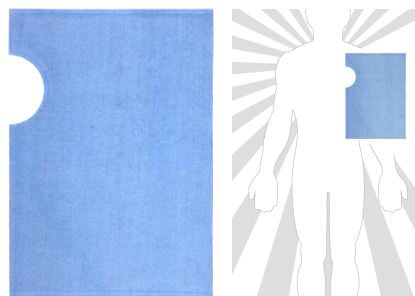

One-time Use

Scatter Armor Shields are lead-free and disposable.

Sterile

Packaged individually in sterile packets.

SA-AGS Scatter Armor Angiography Shield

Transfemoral Access: Angiography, Coronary Catheterization.

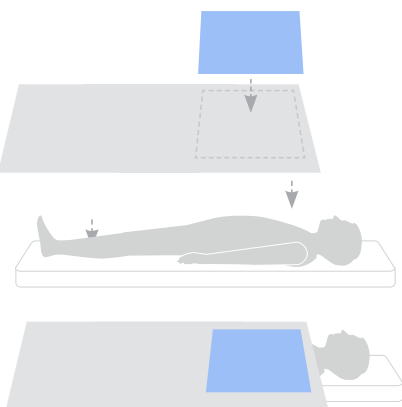
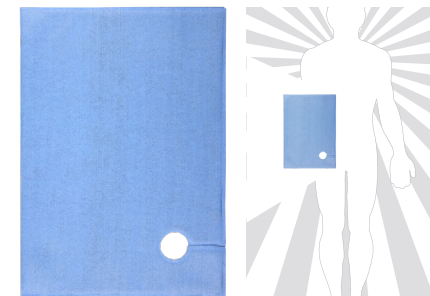

SA-BSS Scatter Armor Biliary Split Shield

Biopsy Procedures, Transjugular Intrahepatic Portosystemic Shunt (TIPS).

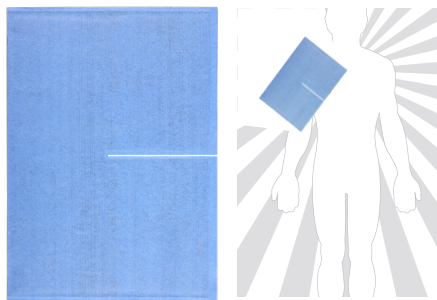

SA-PER Scatter Armor Peripheral Shield

Peripheral procedures where the access is through the femoral artery.

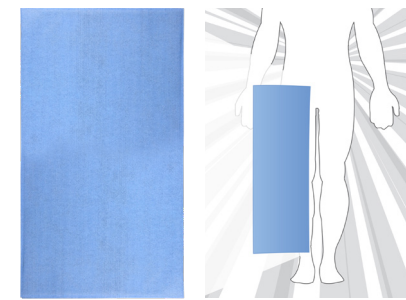

SA-DDD Scatter Armor Dialysis Drape

Dialysis Access and Declothing Procedures.

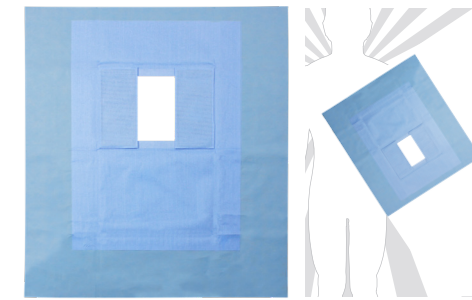



INFAB

**FEATURED
PRODUCT
CATALOG**

INFAB, LLC
info@infabcorp.com
infabcorp.com

1040 Avenida Acaso
Camarillo, CA 93012 USA
Phone: 805.987.5255
Fax: 805.482.8424



REV001 240401