

RADIATION PROTECTION  
**COMPLETE  
CATALOG**  
2026



**INFAB**

# Empowering Healthcare with Advanced Radiation Protection

## Table of Contents

About INFAB.....	3
Revolution Aprons .....	4
Revolution Apron Sizing Chart.....	6
Revolution Apron Colors.....	20
Classic Aprons .....	24
Classic Apron Sizing Chart.....	26
Classic Apron Colors.....	39
Lightning Aprons .....	42
Smart Track .....	44
Accessories .....	46
Scatter Armor Shields.....	56
C-Arm Drapes.....	58
Cassette Covers.....	60
Glasses .....	62
Gloves .....	87
Barriers .....	93
Lockers .....	102
Apron Racks .....	104
Curtains .....	113
Patient Protection.....	119
Patient Positioning .....	122
Certification.....	127
Terms & Conditions .....	128

## Engage & Discover

Join our social channels for the latest in radiation protection and community insights.



**LinkedIn**  
Network with professionals  
and see company updates



**Instagram**  
Follow our visual journey  
and product highlights.



**X (Formerly Twitter)**  
Get the latest news and  
engage with us.



**YouTube**  
Watch our how-to's and  
product insights.



**Facebook**  
Join our community for  
updates and exclusive content.



**Linktree**  
Scan to find all of our  
socials in one click.

\* Product availability and details may change at any time. For current information and availability, please view our online catalog at <https://www.infabcorp.com/catalog>.



## About Us

- **Pioneering Advanced Safety:** Designing and manufacturing innovative radiation protection products since 1981.
- **American Craftsmanship:** Committed to quality with products proudly made in the USA.
- **Technological Breakthroughs:** Our lightest, yet most protective lead-free technology to date.
- **Industry Benchmarks:** Consistently elevating the standards for personal radiation protection.

## Our Mission & Vision

- **Healthcare Longevity:** Dedicated to enhancing the welfare of healthcare professionals through superior protection products.
- **Innovation Leader:** Spearheading the development of lightweight, ergonomic protection that healthcare professionals trust.
- **Global Stewardship:** Fostering a sustainable future with products designed to support healthcare across the globe.

## Connect with Our Sales Team

- **Responsive Service:** Reach out for personalized assistance Monday - Friday, 7am - 4pm Pacific.
- **Direct Support Line:** (805) 987-5255  
Talk to a specialist who understands your needs.
- **Email Inquiry:** [info@infabcorp.com](mailto:info@infabcorp.com)  
For detailed product information and support.
- **Explore Our World:** [www.INFABCORP.com](http://www.INFABCORP.com)  
Discover our full range of protective solutions.

# REVOLUTION

## Key Features



**Brrr° Cooling Interior Fabric**



**Abrasion Resistant**



**Flame Resistant**



**Water Resistant**



**Bacteria Resistant**



**Smart Track**



Monograms can be added either in "Block" or "Script" to any INFAB Aprons

# How to Measure for Your New Apron

- Take all measurements with a cloth measuring tape.
- Measurements should be taken over your clothing.
- Do not attempt to take your own measurements. You should request the help of an assistant for best accuracy.
- Refer to the Find Your Size diagram for proper location of measurements.
- Some apron patterns are cut for specific genders. In these instances, if users of various genders will be sharing aprons, plan to consider male size options. If aprons are being purchased for separate gender use, plan to select the specific gender of the wearer(s) to ensure the best protection/fit.
- Once all measurements have been taken, refer to our sizing chart to find your size.
- If it is determined that a user is between sizes, consider the larger size. Garments that are too big may be made smaller; however, garments that are too small cannot be made larger.

# The Tools You Will Need

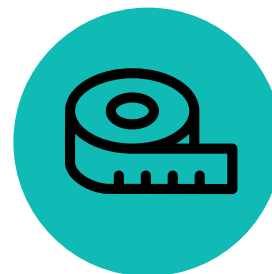

**Cloth Measuring Tape**



**Pencil & Paper**



**Measuring Assistant**

# Find Your Size

Available Length Alteration of (±2" or ±4")



If you see these icons, it means that the apron has its own unique measurements.

### Revolution Vest Length (\*)

Location	xSmall, Small, Medium, Large, xLarge	2xLarge
Front	22" / 56 cm	24" / 61 cm
Back	26" / 66 cm	28" / 66 cm

### Revolution Skirt Length (\*)

Location	xSmall, Small, Medium, Large, xLarge, 2xLarge
Wraparound	22" / 56 cm

### Revolution Front Panel Apron Length (\*)

Location	xSmall, Small, Medium, Large, xLarge, 2xLarge
Front	38" / 97 cm

### Revolution Full Wrap Apron Length (\*)

Location	xSmall, Small, Medium, Large, xLarge, 2xLarge
Wraparound	38" / 97 cm

Measure from high point shoulder to about 1" above the knee. This will be your one piece apron length.

Measure from high point shoulder to desired skirt belt line. Then add 4" to find your vest length.

Measure from your desired skirt belt line to about 1" above the knee. This will be your skirt length.

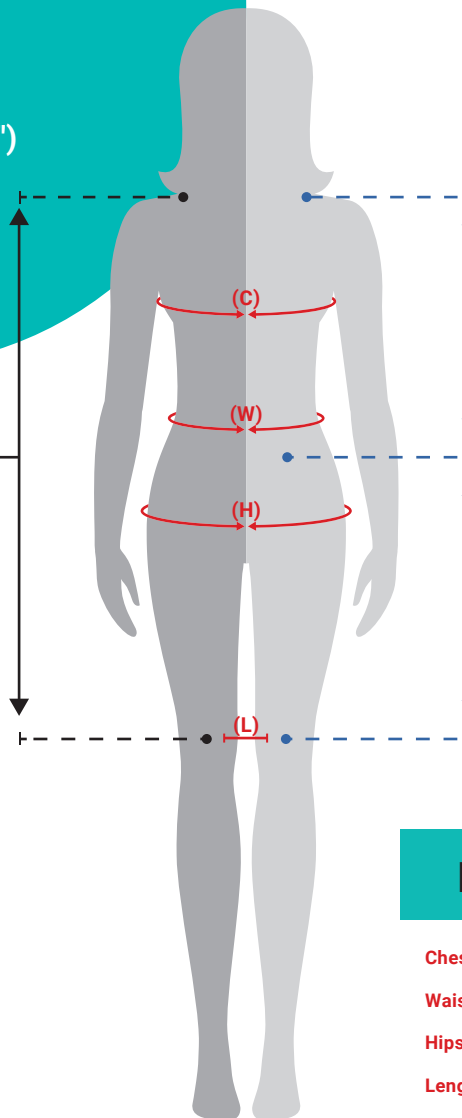

### Revolution 903 Vest Sizing

Location	xSmall	Small	Medium	Large	xLarge	2xLarge
Chest (C)	33"-34" / 84-86 cm	35-36" / 89-91 cm	37-38" / 94-97 cm	39-40" / 99-102 cm	41-42" / 104-107 cm	43-44" / 109-112 cm
Length (L)	21" / 53 cm	21.5" / 55 cm	22" / 56 cm	22.5" / 57 cm	23" / 58 cm	23.5" / 60 cm

### Revolution 903 Skirt Sizing

Location	xSmall	Small	Medium	Large	xLarge	2xLarge
Waist (W)	25-27" / 64-67 cm	28-30" / 71-76 cm	31-33" / 79-84 cm	34-36" / 86-91 cm	37-39" / 94-99 cm	40-42" / 102-107 cm
Length (L)	22" / 56 cm	22" / 56 cm	22" / 56 cm	22" / 56 cm	22" / 58 cm	22" / 58 cm

## HELPFUL HINTS

- Chest (C):** Measure widest part 1" below armhole.
- Waist (W):** Measure narrowest part 1" above navel.
- Hips (H):** Measure widest part of hips.
- Length (L):** We recommend 1" above the knee.

### 603 Unisex Sizing

Location	xSmall	Small	Medium	Large	xLarge	2xLarge
Chest (C)	30-33" / 76-84 cm	34-37" / 86-94 cm	38-41" / 97-104 cm	42-45" / 107-114 cm	46-49" / 117-125 cm	50-52" / 127-132 cm
Waist (W)	25-27" / 64-67 cm	28-31" / 71-79 cm	32-35" / 81-89 cm	36-39" / 91-99 cm	40-43" / 102-109 cm	44-46" / 112-117 cm

### Female Measurements (Applies to All \*)

Location	xSmall	Small	Medium	Large	xLarge	2xLarge
Chest (C)	30-32" / 76-81 cm	33-36" / 84-91 cm	37-39" / 94-99 cm	40-42" / 102-107 cm	43-45" / 109-114 cm	46-48" / 117-122 cm
Waist (W)	25-27" / 64-67 cm	28-30" / 71-76 cm	31-33" / 78-84 cm	34-36" / 86-91 cm	37-39" / 94-99 cm	40-42" / 102-107 cm

Contact us for sizes above 2XL

# Find Your Size

Available Length Alteration of (±2" or ±4")

UNISEX SIZING

SPECIAL SIZING

If you see these icons, it means that the apron has its own unique measurements.

Measure from high point shoulder to desired skirt belt line. Then add 4" to find your vest length.

Measure from your desired skirt belt line to about 1" above the knee. This will be your skirt length.

Measure from high point shoulder to about 1" above the knee. This will be your one piece apron length.

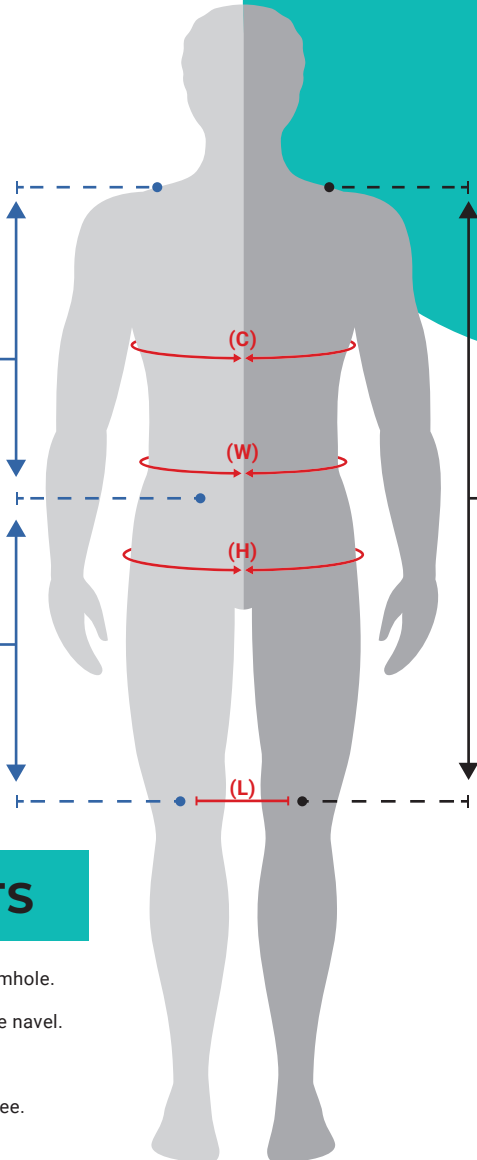

## HELPFUL HINTS

- Chest (C):** Measure widest part 1" below armhole.
- Waist (W):** Measure narrowest part 1" above navel.
- Hips (H):** Measure widest part of hips.
- Length (L):** We recommend 1" above the knee.

### Male Measurements (Applies to All \*)

Location	Small	Medium	Large	xLarge	2xLarge
Chest (C)	34-37" / 86-94 cm	38-41" / 97-104 cm	42-45" / 107-114 cm	46-49" / 117-125 cm	50-52" / 127-132 cm
Waist (W)	28-31" / 71-79 cm	32-35" / 81-89 cm	36-39" / 91-99 cm	40-43" / 102-109 cm	44-46" / 112-117 cm

Contact us for sizes above 2XL

### Revolution Vest Length (\*)

Location	Small, Medium, Large, xLarge	2xLarge
Front	24" / 61 cm	26" / 66 cm
Back	28" / 71 cm	30" / 71 cm

### Revolution Skirt Length (\*)

Location	Small, Medium, Large, xLarge, 2xLarge
Wraparound	22" / 56 cm

### Revolution Front Panel Apron Length (\*)

Location	Small, Medium, Large	xLarge	2xLarge
Front	38" / 97 cm	42" / 107 cm	44" / 112 cm

### Revolution Full Wrap Apron Length (\*)

Location	Small, Medium, Large, xLarge, 2xLarge
Wraparound	38" / 97 cm

### Revolution 903 Vest Sizing

Location	Small	Medium	Large	xLarge	2xLarge
Chest (C)	37-38" / 94-97 cm	39-40" / 99-102 cm	41-42" / 104-107 cm	43-44" / 109-112 cm	45-46" / 114-117 cm
Length (L)	24.5" / 62 cm	25" / 63.5 cm	25.5" / 65 cm	26" / 66 cm	26.5" / 67 cm

### Revolution 903 Skirt Sizing

Location	Small	Medium	Large	xLarge	2xLarge
Waist (W)	28-31" / 71-79 cm	32-35" / 81-89 cm	36-39" / 91-99 cm	40-43" / 102-109 cm	44-46" / 112-117 cm
Length (L)	22" / 56 cm	22" / 56 cm	22" / 56 cm	22" / 58 cm	22" / 58 cm

### 603 Unisex Sizing

Location	Small	Medium	Large	xLarge	2xLarge
Chest (C)	34-37" / 86-94 cm	38-41" / 97-104 cm	42-45" / 107-114 cm	46-49" / 117-125 cm	50-52" / 127-132 cm
Waist (W)	28-31" / 71-79 cm	32-35" / 81-89 cm	36-39" / 91-99 cm	40-43" / 102-109 cm	44-46" / 112-117 cm

# Revolution Core Material Configurations



Overlapping Panels



Non-Overlapping Sections

## PARTIAL OVERLAP

REVOLUTION Vests and Full Wrap Aprons *DO NOT REQUIRE* a full overlap to achieve the stated protection level shown. Skirt Aprons *REQUIRE* a full overlap to achieve the stated protection level shown.

MODELS: 103, B103, L103, BL103

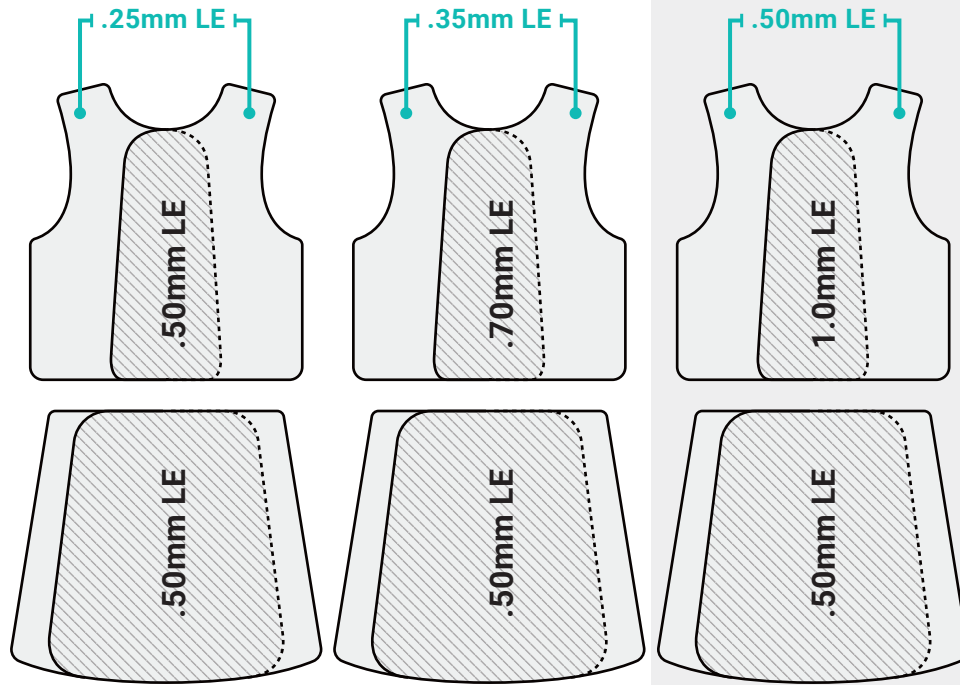

All non-overlapping skirt panels are .25mm LE

.50mm LE Standard Configuration

MODELS: 203, B203

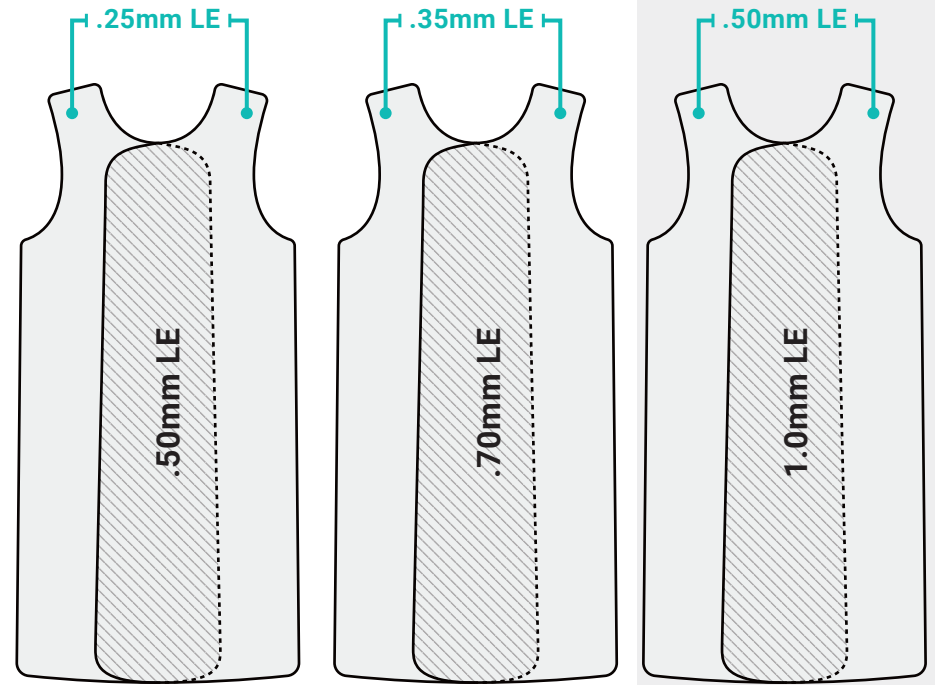

Overlapping panels offer extra protection.

.50mm LE Standard Configuration

# Revolution Core Material Configurations



Overlapping Panels



Non-Overlapping Sections

## NO OVERLAP

REVOLUTION Front Wrap Aprons achieve the stated protection level shown.

**MODELS:** 303, B303, 403, B403, 503, B503, 603, B603

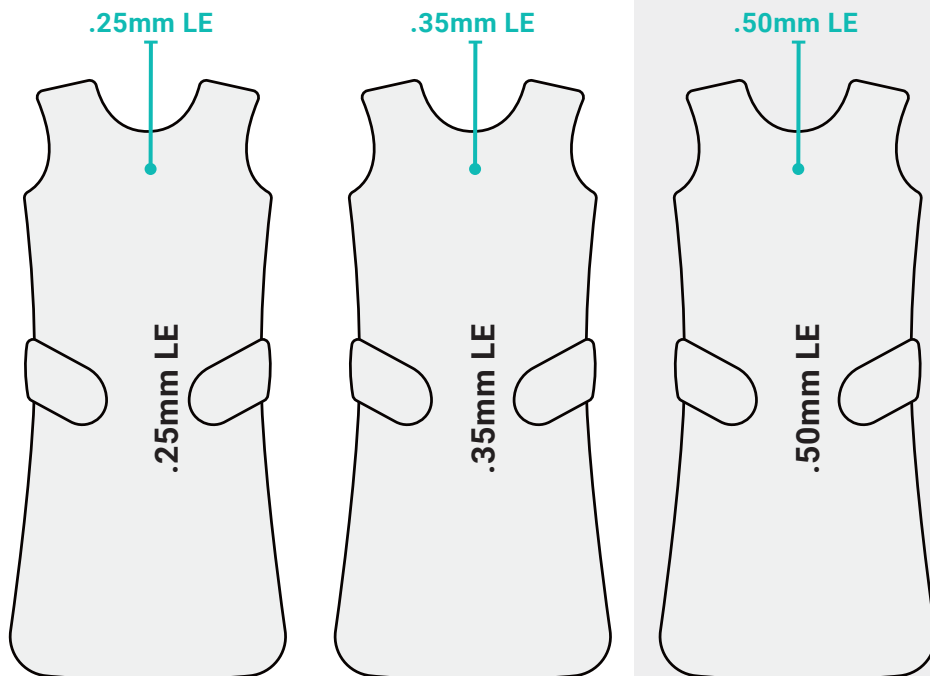

The 603 and B603 back panels are .25mm LE

.50mm LE Standard Configuration

## FULL OVERLAP

REVOLUTION 703 and 803 Aprons *REQUIRE* a full overlap to achieve the stated protection level shown.

**MODELS:** 703, 803

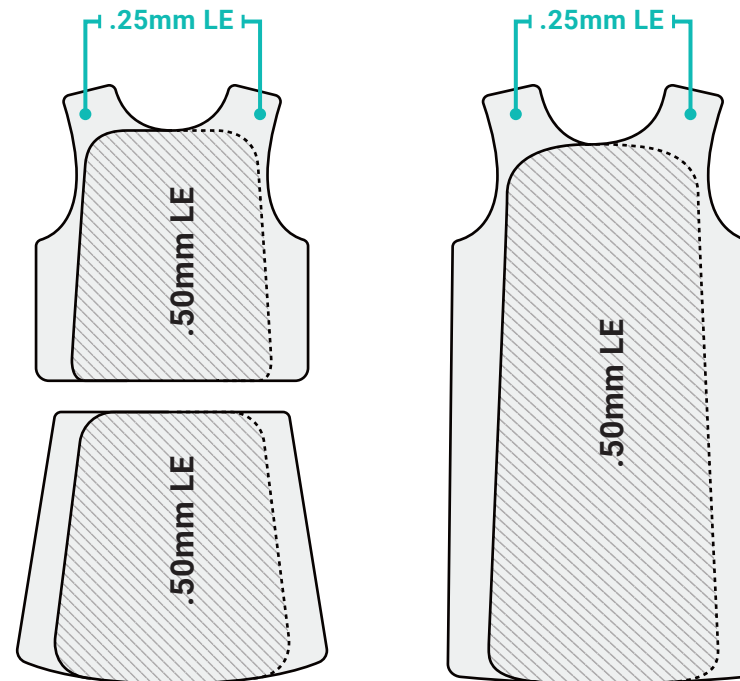

.50mm LE Standard Configuration

All non-overlapping panels are .25m LE



**Color Shown:**  
514 Jewelry Box Blue -  
Black Block



## L103 Revolution Lumbar Vest & Skirt

- Built-in "Black Belt" in vest and skirt for better lumbar support
- Partial overlap to increase protection
- Features interior pocket on both vest and skirt
- Faux front chest pocket for clips only
- "Back Flap" for better weight balance
- Brrr° Cooling Interior Fabric
- Professionally designed for an exceptional fit and comfort
- SmartTrack Track enabled

Model	Description
L103	Revolution Lumbar Vest and Skirt
L103V	Revolution Lumbar Vest
L103S	Revolution Lumbar Skirt
Colors	500, 600, 700, 800, 900, Remix
Core	Lead, Lead-Free
Protection	.25mm LE, .35 mm LE, .50mm LE
Sizes	Male S-2XL Female XS-2XL Length alterations ±2"or ±4"
Fabric	Revolution Fabric with Brrr° Cooling Interior Fabric
Optional Base	BL103 Classic Nylon Colors without Brrr°
Monogram	<b>Block</b> or <i>Script</i>





Color Shown:  
505 Navy - Black Block



Model	Description
103	Revolution Vest and Skirt
103V	Revolution Vest
103S	Revolution Skirt
Colors	500, 600, 700, 800, 900, Remix
Core	Lead, Lead-Free
Protection	.25mm LE, .35 mm LE, .50mm LE
Sizes	Male S-2XL Female XS-2XL Length alterations ±2" or ±4"
Fabric	Revolution Fabric with Brrr° Cooling Interior Fabric
Optional Base	B103 Classic Nylon Colors without Brrr°
Monogram	<b>Block</b> or <i>Script</i>

## 103 Revolution Vest & Skirt

- Features interior pocket on both vest and skirt
- Faux front chest pocket for clips only
- "Back Flap" for better weight balance
- Removable Black Belt® in skirt for better lumbar support
- Partial overlap to increase protection
- Brrr° Cooling Interior Fabric
- Professionally designed for an exceptional fit and comfort
- SmartTrack enabled



Color Shown:  
506 Teal - Black Block

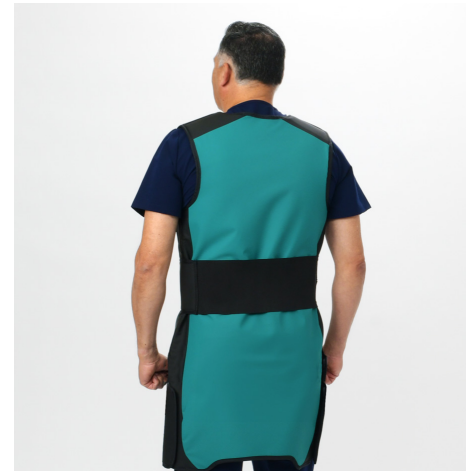

## 203 Revolution Full Wrap Black Belt

- Partial overlap to increase protection
- Hook and loop closure side slits for increased mobility
- Brrr° Cooling Interior Fabric
- Professionally designed for an exceptional fit and comfort
- Snap on, fully adjustable Black Belt® for lumbar support
- SmartTrack enabled

Model	Description
203	Revolution Full Wrap Black Belt
Colors	500, 600, 700, 800, 900, Remix
Core	Lead, Lead-Free
Protection	.25mm LE, .35mm LE, .50mm LE
Sizes	Male S-2XL Female XS-2XL Length alterations ±2" or ±4"
Fabric	Revolution Fabric with Brrr° Cooling Interior Fabric
Optional Base	B203 Classic Nylon Colors without Brrr°
Monogram	<b>Block</b> or <i>Script</i>

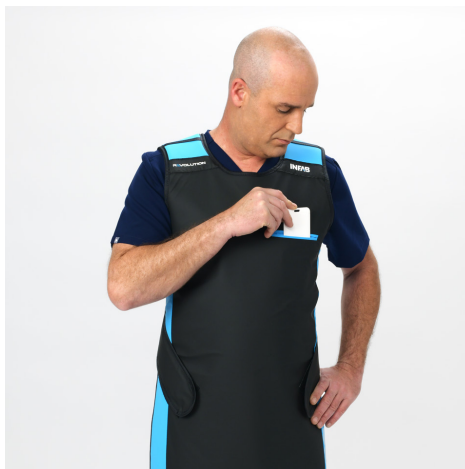
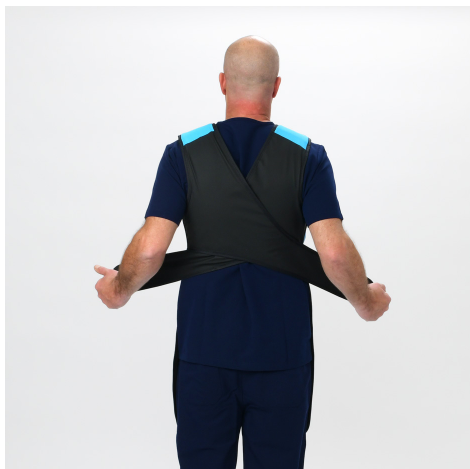

**Color Shown:**  
608 Black - Sky Blue Block

Model	Description
303	Revolution Front
Colors	500, 600, 700, 800, 900, Remix
Core	Lead, Lead-Free
Protection	.25mm LE, .35 mm LE, .50mm LE
Sizes	Male S-2XL Female XS-2XL Length alterations ±2" or ±4"
Fabric	Revolution Fabric with Brrr° Cooling Interior Fabric
Optional Base	B303 Classic Nylon Colors without Brrr°
Monogram	<b>Block</b> or <i>Script</i>

## 303 Revolution Front

- Criss-cross back straps to provide weight relief and lumbar support
- Brrr° Cooling Interior Fabric
- Professionally designed for an exceptional fit and comfort
- SmartTrack enabled



**Color Shown:**  
513 Tide Red - Black Block



## 403 Revolution Front Elastic Back

- Criss-cross elastic back straps to provide weight relief and lumbar support
- Brrr<sup>®</sup> Cooling Interior Fabric
- Professionally designed for an exceptional fit and comfort
- SmartTrack enabled

Model	Description
403	Revolution Front Elastic Back
Colors	500, 600, 700, 800, 900, Remix
Core	Lead, Lead-Free
Protection	.25mm LE, .35 mm LE, .50mm LE
Sizes	Male S-2XL Female XS-2XL Length alterations ±2" or ±4"
Fabric	Revolution Fabric with Brrr <sup>®</sup> Cooling Interior Fabric
Optional Base	B403 Classic Nylon Colors without Brrr <sup>®</sup>
Monogram	<b>Block</b> or <i>Script</i>



**Color Shown:**  
504 Pink - Black Block

Model	Description
503	Revolution Front Black Belt
Colors	500, 600, 700, 800, 900, Remix
Core	Lead, Lead-Free
Protection	.25mm LE, .35 mm LE, .50mm LE
Sizes	Male S-2XL Female XS-2XL Length alterations ±2" or ±4"
Fabric	Revolution Fabric with Brrr® Cooling Interior Fabric
Optional Base	B503 Classic Nylon Colors without Brrr®
Monogram	<b>Block</b> or <i>Script</i>

**503**  
**Revolution Front Black Belt**

- Brrr® Cooling Interior Fabric
- 503 comes with a snap on, fully adjustable Black Belt®
- Professionally designed for an exceptional fit and comfort
- SmartTrack enabled



**Color Shown:**  
602 Black - Fuchsia Block

## 603 Revolution Full Wrap Elastic Back

- Brrr° Cooling Interior Fabric
- Professionally designed for an exceptional fit and comfort
- SmartTrack enabled

Model	Description
603	Revolution Full Wrap Elastic Back
Colors	500, 600, 700, 800, 900, Remix
Core	Lead, Lead-Free
Protection	.25mm LE, .35 mm LE, .50mm LE
Sizes	Unisex XS-2XL Length Alterations ±2" or ±4"
Fabric	Revolution Fabric with Brrr° Cooling Interior Fabric
Optional Base	B603 Classic Nylon Colors without Brrr°
Monogram	<b>Block</b> or <i>Script</i>



**Color Shown:**  
510 Purple - Black Block



Model	Description
703	Revolution Full Overlap Lumbar Vest & Skirt
Colors	500, 600, 700, 800, 900, Remix
Core	Lead, Lead-Free
Protection	.50mm LE
Sizes	Male S-2XL Female XS-2XL Length alterations ±2" or ±4"
Fabric	Revolution Fabric with Brrr° Cooling Interior Fabric
Monogram	<b>Block</b> or <i>Script</i>

**703**  
**Revolution Full Overlap Lumbar Vest & Skirt**

- Full overlap
- Built-in Black Belt® in vest and skirt for better lumbar support
- Brrr° Cooling Interior Fabric
- Professionally designed for an exceptional fit and comfort
- SmartTrack enabled



**Color Shown:**  
515 Orange - Black Block



## 803 Revolution Black Belt® Wrap

- Full overlap
- Hook and loop closure side slits for increased mobility
- Brrr® Cooling Interior Fabric
- Professionally designed for an exceptional fit and comfort
- Snap on, fully adjustable Black Belt®
- SmartTrack enabled

Model	Description
803	Revolution Black Belt Wrap
Colors	500 Series, 600 Series, 700 Series, 800 Series, 900 Series, Remix
Core	Lead, Lead-Free
Protection	.50mm LE
Sizes	Female XS-2XL Male S-2XL Length Alterations ±2" or ±4"
Fabric	Revolution Fabric with Brrr® Cooling Interior Fabric
Monogram	<b>Block</b> or <i>Script</i>



**Color Shown:**  
512 Ducks Green  
- Black Block

Model	Description
903	Revolution Reverse Vest & Skirt
Colors	500 Series, 600 Series, 700 Series, 800 Series, 900 Series, Remix, Nylon
Core	Lead, Lead-Free
Protection	.25mm LE, .35 mm LE, .50mm LE
Sizes	Female XS-2XL Male S-2XL Length Alterations ±2" or ±4" on skirt only
Fabric	Revolution Fabric with Brrr° Cooling Interior Fabric
Monogram	<b>Block</b> or <i>Script</i>

## 903 Revolution Reverse Vest & Skirt

- Criss-cross elastic back straps to provide weight relief and lumbar support
- Adjustable shoulder strap ensures a precise fit
- Brrr° Cooling Interior Fabric
- Professionally designed for an exceptional fit and comfort
- SmartTrack enabled

# Revolution Colors

## Color

700 SERIES



Color Shown: 706



## Color + Black

500 SERIES



Color Shown: 506



## Black + Color

600 SERIES



Color Shown: 606

- |  |                                 |                                       |                               |
|--|---------------------------------|---------------------------------------|-------------------------------|
|  |                                 |                                       |                               |
| 601<br>Black - Red Block                 | 613<br>Black - Tide Red Block   | 615<br>Black - Orange Block           | 607<br>Black - Yellow Block   |
|  |                                 |                                       |                               |
| 612<br>Black - Ducks Green Block         | 606<br>Black - Teal Block       | 614<br>Black - Jewelry Box Blue Block | 608<br>Black - Sky Blue Block |
|  |                                 |                                       |                               |
| 617<br>Black - Light Blue Serenity Block | 618<br>Black - Royal Blue Block | 605<br>Black - Navy Block             | 610<br>Black - Purple Block   |
|  |                                 |                                       |                               |
| 602<br>Black - Fuchsia Block             | 604<br>Black - Pink Block       | 619<br>Black - Coral Block            | 609<br>Black - Grey Black     |
|  |                                 |                                       |                               |
| 611<br>Black - White Block               |                                 |                                       |                               |

## Color + White

800 SERIES



Color Shown: 806

- |  |                                 |                                       |                               |
|--|---------------------------------|---------------------------------------|-------------------------------|
|  |                                 |                                       |                               |
| 801<br>Red - White Block                 | 813<br>Tide Red - White Block   | 815<br>Orange - White Block           | 807<br>Yellow - White Block   |
|  |                                 |                                       |                               |
| 812<br>Ducks Green - White Block         | 806<br>Teal - White Block       | 814<br>Jewelry Box Blue - White Block | 808<br>Sky Blue - White Block |
|  |                                 |                                       |                               |
| 817<br>Light Blue Serenity - White Block | 818<br>Royal Blue - White Block | 805<br>Navy - White Block             | 810<br>Purple - White Block   |
|  |                                 |                                       |                               |
| 802<br>Fuchsia - White Block             | 804<br>Pink - White Block       | 819<br>Coral - White Block            | 809<br>Grey - White Block     |
|  |                                 |                                       |                               |
| 800<br>Black - White Block               |                                 |                                       |                               |

# Revolution Colors

## White + Color

900 SERIES



Color Shown: 906

- |   |  |  |                                      |
|---|--|--|--------------------------------------|
|   |  |  |                                      |
| <b>901</b><br>White - Red Block           | <b>913</b><br>White - Tide Red Block   | <b>915</b><br>White - Orange Block           | <b>907</b><br>White - Yellow Block   |
|   |  |  |                                      |
| <b>912</b><br>White - Ducks Green Block   | <b>906</b><br>White - Teal Block       | <b>914</b><br>White - Jewelry Box Blue Block | <b>908</b><br>White - Sky Blue Block |
|   |  |  |                                      |
| <b>917</b><br>White - Light Blue Serenity | <b>918</b><br>White - Royal Blue Block | <b>905</b><br>White - Navy Block             | <b>910</b><br>White - Purple Block   |
|   |  |  |                                      |
| <b>902</b><br>White - Fuchsia Block       | <b>904</b><br>White - Pink Block       | <b>919</b><br>White - Coral Block            | <b>909</b><br>White - Grey Block     |
|   |  |  |                                      |
| <b>900</b><br>White - Black Block         |  |  |                                      |

## Color + Color

REMIX SERIES



706 - Teal



713 - Tide Red

# Revolution Base



**BL103**  
Vest & Skirt  
Lumbar Belt



**B103**  
Vest & Skirt



**B203**  
Full Wrap Apron -  
Lumbar Belt



**B303**  
Front Panel Apron

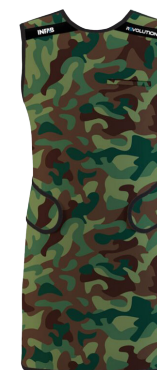

**B403**  
Front Panel Apron -  
Elastic Back



**B503**  
Front Panel Apron -  
Lumbar Belt



**B603**  
Full Wrap Apron -  
Elastic Back

Revolution Base offers all the comfort and protection of our premium Revolution line, but with our classic nylon colors and patterns. Revolution Base does not include Revolution Fabric, Color-Blocking or Brrr®.

Size	Female XS-2XL Male S-2XL
Fabric	Nylon
Protection	.25mm LE, .35mm LE, and .50mm LE (Options Vary per Model)
Core	Lead or Lead-Free
Color	Classic color & patterns options only

# Classic Aprons

## Key Features



Water Resistant



Abrasion Resistant



Flame Resistant



Smart Track



Bacteria Resistant



Custom Patterns

Monograms can be added either in "Block" or "Script" to any INFAB Aprons



# How to Measure for Your New Apron

- Take all measurements with a cloth measuring tape.
- Measurements should be taken over your clothing.
- Do not attempt to take your own measurements. You should request the help of an assistant for best accuracy.
- Refer to the Find Your Size diagram for proper location of measurements.
- Some apron patterns are cut for specific genders. In these instances, if users of various genders will be sharing aprons, plan to consider male size options. If aprons are being purchased for separate gender use, plan to select the specific gender of the wearer(s) to ensure the best protection/fit.
- Once all measurements have been taken, refer to our sizing chart to find your size.
- If it is determined that a user is between sizes, consider the larger size. Garments that are too big may be made smaller; however, garments that are too small cannot be made larger.

# The Tools You Will Need

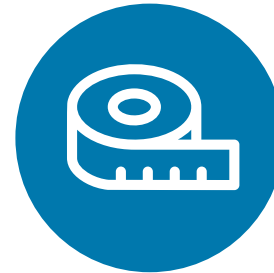

**Cloth Measuring Tape**



**Pencil & Paper**



**Measuring Assistant**

# Find Your Size

## HELPFUL HINTS

- Chest (C):** Measure widest part 1" below armhole.
- Waist (W):** Measure narrowest part 1" above navel.
- Hips (H):** Measure widest part of hips.
- Length (L):** We recommend 1" above the knee.

### Classic Front Panel Apron Length (\*)

Location	xSmall, Small, Medium, Large, xLarge, 2xLarge
Front	38" / 97 cm

### Classic Full Wrap Apron Length (\*)

Location	xSmall, Small, Medium, Large, xLarge, 2xLarge
Wraparound	38" / 97 cm

### Reverse & Elastic Vest Sizing (\*)

Location	xSmall	Small	Medium	Large	xLarge	2xLarge
Length (L)	24" / 61 cm	24" / 61 cm	26" / 66 cm	27" / 69 cm	28" / 71 cm	29" / 74 cm

### Classic Vest Sizing (\*)

Location	xSmall	Small	Medium	Large	xLarge	2xLarge
Length (L)	20" / 51 cm	22" / 56 cm	24" / 61 cm	25" / 64 cm	26" / 66 cm	27" / 69 cm

### Classic Skirt Sizing (\*)

Location	xSmall	Small	Medium	Large	xLarge	2xLarge
Length (L)	18" / 47 cm	20" / 51 cm	22" / 56 cm	23" / 58 cm	24" / 61 cm	25" / 64 cm

## SPECIAL SIZING

If you see this icon, it means that the apron has its own unique measurements.

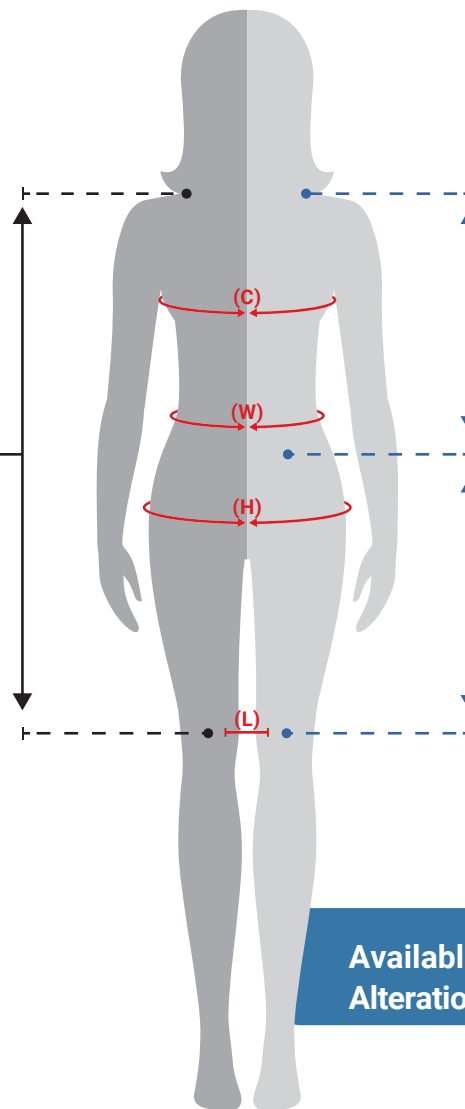

Measure from high point shoulder to desired skirt belt line. Then add 4" to find your vest length.

Measure from your desired skirt belt line to about 1" above the knee. This will be your skirt length.

Available Length Alterations in increments of ±1"

### Female Measurements (Applies to All \*)

Location	xSmall	Small	Medium	Large	xLarge	2xLarge
Chest (C)	30-32" / 76-81 cm	33-36" / 84-91 cm	37-39" / 94-99 cm	40-42" / 102-107 cm	43-45" / 109-114 cm	46-48" / 117-122 cm
Waist (W)	25-27" / 64-67 cm	28-30" / 71-76 cm	31-33" / 78-84 cm	34-36" / 86-91 cm	37-39" / 94-99 cm	40-42" / 102-107 cm

Contact us for sizes above 2XL

# Find Your Size

**SPECIAL SIZING**

If you see this icon, it means that the apron has its own unique measurements.

Measure from high point shoulder to desired skirt belt line. Then add 4" to find your vest length.

Measure from your desired skirt belt line to about 1" above the knee. This will be your skirt length.

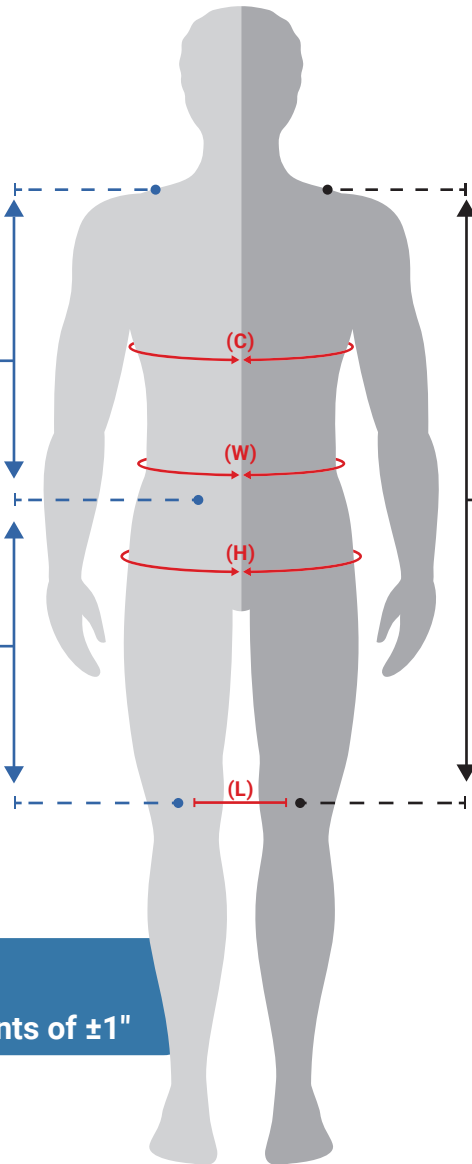

Measure from high point shoulder to about 1" above the knee. This will be your one piece apron length.

**Available Length Alterations in increments of ±1"**

**Male Measurements (Applies to All \*)**

Location	Small	Medium	Large	xLarge	2xLarge
Chest (C)	34-37" / 86-94 cm	38-41" / 97-104 cm	42-45" / 107-114 cm	46-49" / 117-125 cm	50-52" / 127-132 cm
Waist (W)	28-31" / 71-79 cm	32-35" / 81-89 cm	36-39" / 91-99 cm	40-43" / 102-109 cm	44-46" / 112-117 cm

Contact us for sizes above 2XL

**HELPFUL HINTS**

- Chest (C):** Measure widest part 1" below armhole.
- Waist (W):** Measure narrowest part 1" above navel.
- Hips (H):** Measure widest part of hips.
- Length (L):** We recommend 1" above the knee.

**Classic Front Panel Apron Length (\*)**

Location	Small, Medium, Large	xLarge	2xLarge
Front	38" / 97 cm	42" / 107 cm	44" / 112 cm

**Classic Full Wrap Apron Length (\*)**

Location	Small, Medium, Large, xLarge, 2xLarge
Wraparound	38" / 97 cm

**Reverse & Elastic Vest Sizing (\*)**

Location	Small	Medium	Large	xLarge	2xLarge
Length (L)	25" / 64 cm	27" / 69 cm	28" / 71 cm	30" / 76 cm	30" / 76 cm

**Classic Vest Sizing (\*)**

Location	Small	Medium	Large	xLarge	2xLarge
Length (L)	22" / 56 cm	24" / 61 cm	25" / 64 cm	26" / 66 cm	28" / 71 cm

**Classic Skirt Sizing (\*)**

Location	Small	Medium	Large	xLarge	2xLarge
Length (L)	20" / 51 cm	22" / 56 cm	23" / 58 cm	24" / 61 cm	25" / 64 cm

# Classic Core Material Configurations



Overlapping Panels



Non-Overlapping Sections

## FULL OVERLAP

CLASSIC Full Wrap Vest and Skirt Aprons *REQUIRE* a full overlap to achieve the stated protection level shown.

### CLASSIC: VAS

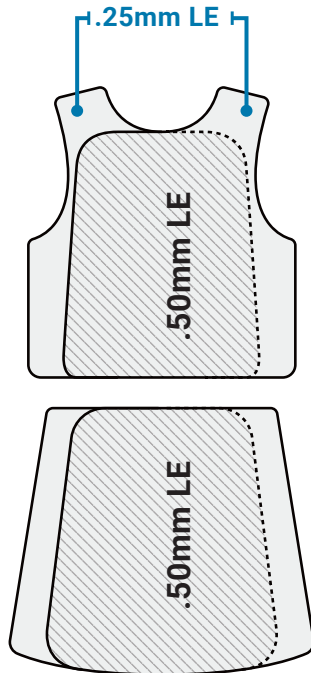

.50mm LE Standard Configuration

### CLASSIC: LSW, FCW

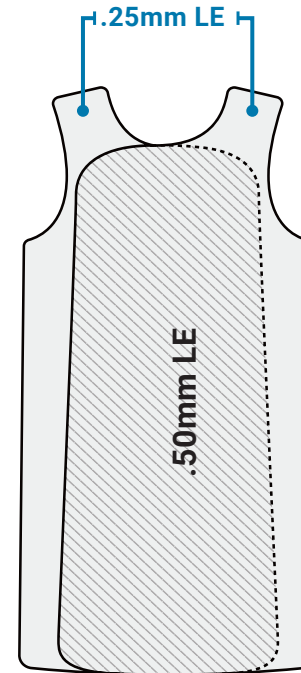

.50mm LE Standard Configuration

# Classic Core Material Configurations



Overlapping Panels



Non-Overlapping Sections

## NO OVERLAP

CLASSIC Front Wrap Apron's and Vest's achieve the stated protection level shown.  
Only the CLASSIC Skirt **REQUIRE** a full overlap to achieve the stated protection level shown.

CLASSIC: AWC, EBA, LSF, MWA, WBT, SPL, SDO, SDA, TFAM, DTL-TECH, DTL-PANO, DTL-ADULT, DTL-ADULT-TC, DTL-CHILD, DTL-CHILD-TC • EVAS, RVAS

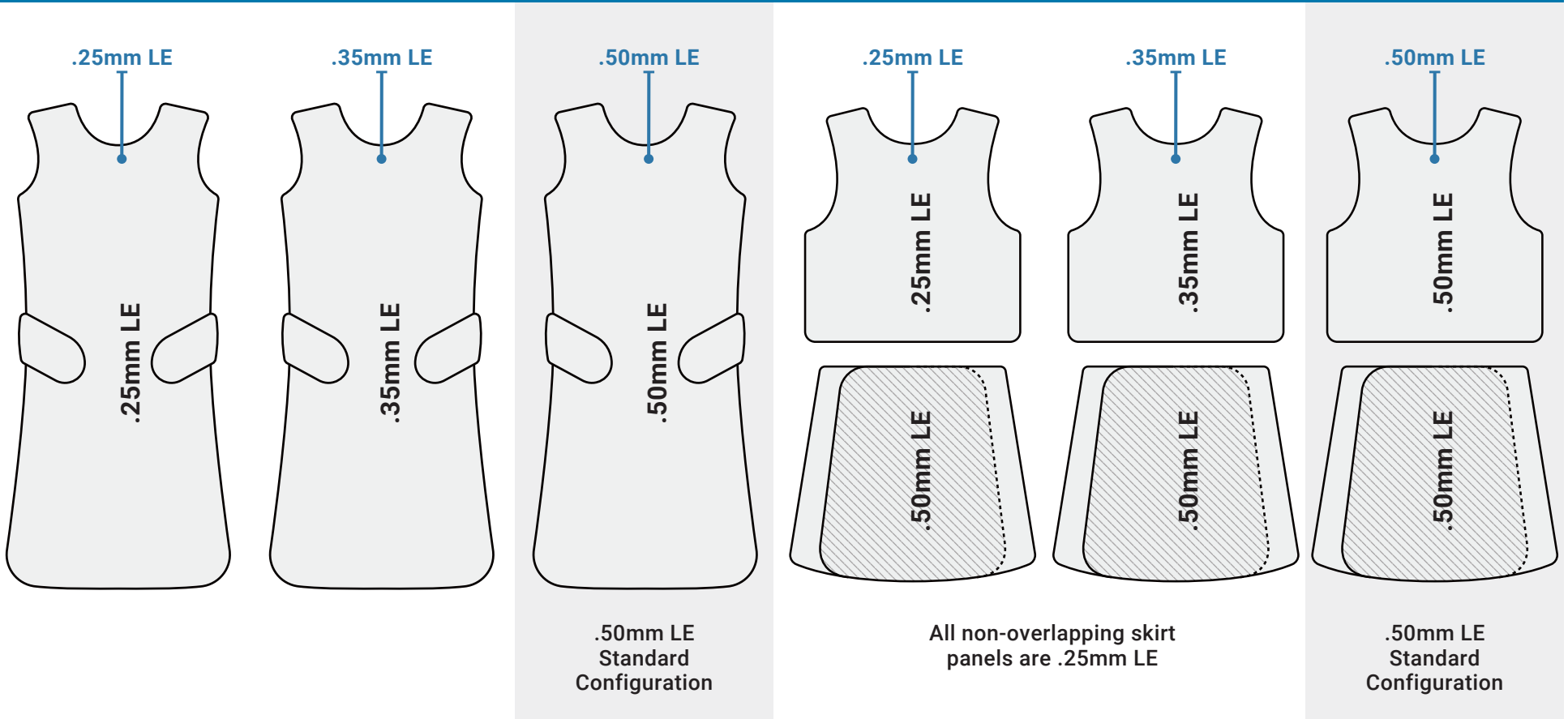

## VAS Vest and Skirt



The Classic Vest and Skirt apron provides full overlap protection and maximum weight distribution between the shoulders and hips, eliminating stress on the upper and lower back. SmartTrack enabled.

- SIZE:** xSmall - 2xLarge (Pages 28-29)
- FABRIC:** Nylon (with a double welt pocket)
- PROTECTION:** .50mm LE
- CORE:** Lead, Lead-Free
- PRINT:** Solid and pattern options (Pages 39-40)

## RVAS Reverse Vest & Skirt



The Reverse Vest and Skirt apron provides maximum weight distribution. Criss-cross elastic back straps provide weight relief and lumbar support, while the adjustable shoulder strap ensures a precise fit. SmartTrack enabled.

- SIZE:** xSmall - 2xLarge (Pages 28-29)
- FABRIC:** Nylon (with a double welt pocket)
- PROTECTION:** .25mm LE, .35mm LE, and .50mm LE
- CORE:** Lead, Lead-Free
- PRINT:** Solid and pattern options (Pages 39-40)

**EVAS** Elastic Vest & Skirt



The Elastic Vest and Skirt apron provides maximum weight distribution. Criss-cross elastic back straps provide weight relief and lumbar support, while the adjustable back strap ensures a precise fit. SmartTrack enabled.

- SIZE:** xSmall - 2xLarge (Pages 28-29)
- FABRIC:** Nylon (with a double welt pocket)
- PROTECTION:** .25mm LE, .35mm LE, and .50mm LE
- CORE:** Lead, Lead-Free
- PRINT:** Solid and pattern options (Pages 39-40)

**LSW** Full Overlap with Lumbar Belt



The Black Belt Full Wrap apron offers maximum protection with full overlap, featuring a snap-on, fully adjustable lumbar Black Belt®. This apron combines comfort with superior lumbar support, which reduces fatigue and upper back stress during lengthy procedures. Built-in slits on each side with hook and loop closures provide increased mobility. SmartTrack enabled.

- SIZE:** xSmall - 2xLarge (Pages 28-29)
- FABRIC:** Nylon (with a double welt pocket)
- PROTECTION:** .50mm LE
- CORE:** Lead, Lead-Free
- PRINT:** Solid and pattern options (Pages 39-40)

**MWA** Special Wrap



The Special Wrap apron is uniquely designed to offer full protection with an adjustable shoulder strap and front belt buckle closure. SmartTrack enabled.

- SIZE:** xSmall - 2xLarge (Pages 28-29)
- FABRIC:** Nylon (with a double welt pocket)
- PROTECTION:** .25mm LE, .35mm LE, and .50mm LE
- CORE:** Lead, Lead-Free
- PRINT:** Solid and pattern options (Pages 39-40)

**FCW** Full Coat Wrap



The Full Coat Wrap offers maximum front and back full overlap protection. Built-in slits on each side with hook and loop closures provide increased mobility. SmartTrack enabled.

- SIZE:** xSmall - 2xLarge (Pages 28-29)
- FABRIC:** Nylon (with a double welt pocket)
- PROTECTION:** .50mm LE
- CORE:** Lead, Lead-Free
- PRINT:** Solid and pattern options (Pages 39-40)

**AWC** Weight Reliever



**EBA** Elastic Back



Print Shown: LT221-16 Lovely Lemons



Print Shown: SH-52 Mixed Dogs

The Weight Reliever front protection apron features side closure straps at the waist which relieve weight from the shoulders and adjust for the most comfortable fit. SmartTrack enabled.

- SIZE:** xSmall - 2xLarge (Pages 28-29)
- FABRIC:** Nylon (with a double welt pocket)
- PROTECTION:** .25mm LE, .35mm LE, and .50mm LE
- CORE:** Lead, Lead-Free
- PRINT:** Solid and pattern options (Pages 39-40)

The Elastic Back front protection apron features elastic side closure straps providing weight relief, comfort, and flexibility. SmartTrack enabled.

- SIZE:** xSmall - 2xLarge (Pages 28-29)
- FABRIC:** Nylon (with a double welt pocket)
- PROTECTION:** .25mm LE, .35mm LE, and .50mm LE
- CORE:** Lead, Lead-Free
- PRINT:** Solid and pattern options (Pages 39-40)

**LSF** Black Belt Front



The Black Belt Front Protection apron provides frontside body protection while offering snap-on, fully adjustable Black Belt® lumbar support. The built-in back strap provides better weight distribution between the shoulders and waist. SmartTrack enabled.

- SIZE:** xSmall - 2xLarge (Pages 28-29)
- FABRIC:** Nylon (with a double welt pocket)
- PROTECTION:** .25mm LE, .35mm LE, and .50mm LE
- CORE:** Lead, Lead-Free
- PRINT:** Solid and pattern options (Pages 39-40)

**WBT** Wide Belt



The Wide Belt apron offers frontside protection with a belt and buckle closure, adjustable for a comfortable fit. SmartTrack enabled.

- SIZE:** xSmall - 2xLarge (Pages 28-29)
- FABRIC:** Nylon (with a double welt pocket)
- PROTECTION:** .25mm LE, .35mm LE, and .50mm LE
- CORE:** Lead, Lead-Free
- PRINT:** Solid and pattern options (Pages 39-40)

**SPL** Budget Saver



Print Shown: SH-19 Pink Paisley

The Budget Saver front protection apron features criss-cross tie straps for a secure, snug fit and comfortable shoulder pads. SmartTrack enabled.

- SIZE:** xSmall - 2xLarge (Pages 28-29)
- FABRIC:** Nylon
- PROTECTION:** .25mm LE, .35mm LE, and .50mm LE
- CORE:** Lead, Lead-Free
- PRINT:** Solid and pattern options (Pages 39-40)

**SDO** Surgery Drop Off



Print Shown: SH-31 Sugar Skulls

The Surgery Drop Off front protection apron is designed to be removed without breaking the sterile field. Additional handle straps located on top of shoulders for easy removal or drop off. Attaches in the front with hook and loop closures. SmartTrack enabled.

- SIZE:** xSmall - 2xLarge (Pages 28-29)
- FABRIC:** Nylon (with a double welt pocket)
- PROTECTION:** .25mm LE, .35mm LE, and .50mm LE
- CORE:** Lead, Lead-Free
- PRINT:** Solid and pattern options (Pages 39-40)

**SDA** Surgery Drop Away



The Surgery Drop Away front protection apron features hook and loop closures at the top of each shoulder for easy removal without breaking the sterile field. The back strap provides a secure fit. SmartTrack enabled.

- SIZE:** xSmall - 2xLarge (Pages 28-29)
- FABRIC:** Nylon (with a double welt pocket)
- PROTECTION:** .25mm LE, .35mm LE, and .50mm LE
- CORE:** Lead, Lead-Free
- PRINT:** Solid and pattern options (Pages 39-40)

**TFA** Tri-Flap



The Tri-Flap apron features a split front panel to provide protection and comfort while seated. Criss-cross straps attach in front with a hook and loop closure. SmartTrack enabled.

- SIZE:** xSmall - 2xLarge (Pages 28-29)
- FABRIC:** Nylon (with a double welt pocket)
- PROTECTION:** .25mm LE, .35mm LE, and .50mm LE
- CORE:** Lead, Lead-Free
- PRINT:** Solid and pattern options (Pages 39-40)

**DTL-TECH** Dental Technician Apron

**DTL-PANO** Pano Cape Dental Apron



Print Shown: Custom



Model: DTL-PANO Print Shown: 114 with 107 Trim

The Dental Technician Apron front protection apron features criss-cross tie straps for a secure, snug fit and comfortable shoulder pads. SmartTrack enabled.

The Pano Cap Dental Apron drapes over your patient's shoulders. The inner liner of this cape uses a non-slip material and fastens in the back with a hook and loop closure. SmartTrack enabled.

- SIZE:** 24" W x 36" L
- FABRIC:** Nylon
- PROTECTION:** .35mm LE
- CORE:** Lead, Lead-Free
- PRINT:** Solid and pattern options (Pages 39-40)

- SIZE:** 23" W x 25" L
- FABRIC:** Nylon
- PROTECTION:** .35mm LE
- CORE:** Lead, Lead-Free
- PRINT:** Solid and pattern options (Pages 39-40)

## DTL-ADULT Adult Dental Apron



Model: DTL-ADULT Print Shown: 169 & 188

**DTL-ADULT-TC**

Dental Apron with attached thyroid collar

## DTL-CHILD Child Dental Apron



Model: DTL-CHILD Print Shown: 217 & 176

**DTL-CHILD-TC**

Dental Apron with attached thyroid collar

The Adult Dental Apron provides front protection for the patient, using a non-slip material to keep it firmly in position. An attached thyroid collar option is available in this style. SmartTrack enabled.

- SIZE:** 24" W x 27" L
- FABRIC:** Nylon
- PROTECTION:** .35mm LE
- CORE:** Lead, Lead-Free
- PRINT:** Solid and pattern options (Pages 39-40)

The Child Dental Apron provides front protection for the patient, using a non-slip material to keep it firmly in position. An attached thyroid collar option is available in this style. SmartTrack enabled.

- SIZE:** 18" W x 24" L
- FABRIC:** Nylon
- PROTECTION:** .35mm LE
- CORE:** Lead, Lead-Free
- PRINT:** Solid and pattern options (Pages 39-40)

# Apron Colors

We use high quality nylon and polyester fabrics for all of our products. A polyurethane coating seals the fabric and makes it easier to clean. Color-fast dyes won't transfer to your clothing.



105 Red



154 Orange



204 Gold



118 Fuchsia



111 Burgundy



119 Purple



202 Sky Blue



108 Royal Blue



104 Navy



107 Kelly Green



129 Hunter Green



117 Teal



205 Charcoal

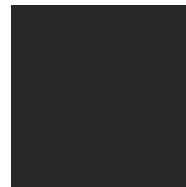

114 Black



112 Grey

## PATTERNS

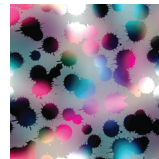
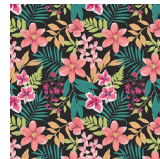
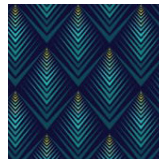
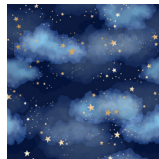
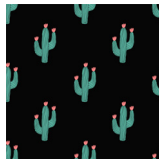
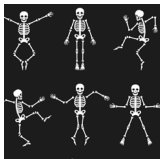

## More Colors & Patterns

Browse all 100+ colors and patterns  
at [infabcorp.com/colors](https://infabcorp.com/colors)

## Ripstop Fabric

Woven nylon with a special reinforcing technique resistant to tearing. A diamond pattern in the weave gives them their distinctive look.



190 Blue



192 Gray

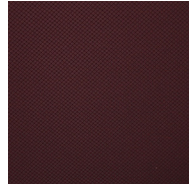

194 Burgundy



196 Bronze

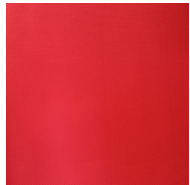

197 Red

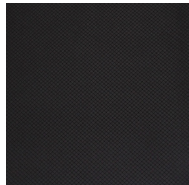

198 Black

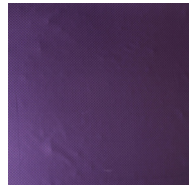

199 Purple



200 Hunter Green



## Trim Colors

INFAB offers a variety of trim colors. Color-fast dyes won't transfer to your clothing. Colors may vary slightly from screen to print.



105 Red



154 Orange



204 Gold



118 Fuchsia



111 Burgundy



119 Purple



108 Royal Blue



104 Navy Blue

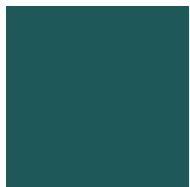

117 Teal



107 Kelly Green



129 Hunter Green

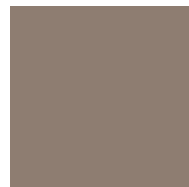

103 Taupe



106 Chocolate



205 Charcoal



112 Grey



114 Black

# Personalize Your Apron

Make it yours with monograms, patches, or your organization's logo.

## Monogram

### Block

**Aa Bb Cc Dd Ee Ff Gg  
Hh Ii Jj Kk Ll Mm Nn Oo  
Pp Qq Rr Ss Tt Uu Vv  
Ww Xx Yy Zz  
1234567890**

### Script

***Aa Bb Cc Dd Ee Ff Gg  
Hh Ii Jj Kk Ll Mm Nn Oo  
Pp Qq Rr Ss Tt Uu Vv  
Ww Xx Yy Zz  
1234567890***

Add your name, credentials, or department to personalize your radiation protection.

## Patch

### Removable Hook & Loop Monogram Patch

Available to be added to any apron. Also available as an adhesive option for existing aprons.



- Swap between aprons
- Update without replacing
- Professional appearance

## Your Logo

### Add Your Organization's Branding

Feature your hospital, clinic, or practice logo on any INFAB apron. Perfect for team identification and professional branding.

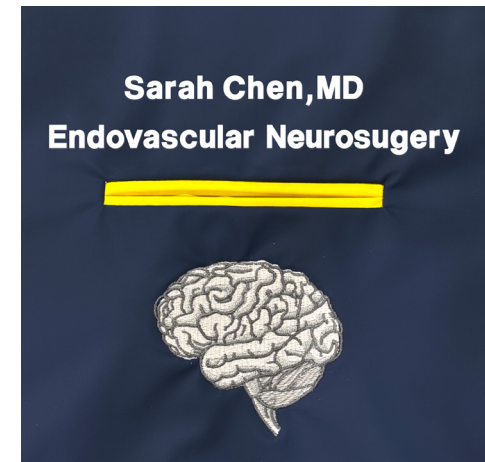

- Any vector logo accepted
- Multiple placement options
- Facility outfitting programs



[View All Fabrics](#)

### Quick Ship Aprons



Ready to Ship



Smart Track



Abrasion Resistant



Flame Resistant



Water Resistant

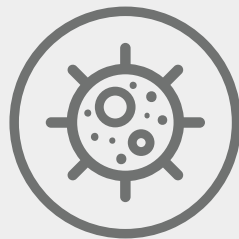

Bacteria Resistant

### Available in Six Colors



**114:**  
Black



**108:**  
Royal Blue

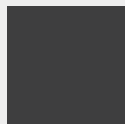

**205:**  
Charcoal



**119:**  
Purple



**105:**  
Red



**117:**  
Teal



Model: UVS Color Shown: Purple

The Lightning Vest and Skirt apron provides partial overlap protection and maximum weight distribution between the shoulders and hips, eliminating stress on the upper and lower back. SmartTrack enabled.

- SIZE:** Small - 2xLarge
- FABRIC:** Nylon (with a double welt pocket)
- PROTECTION:** .35mm LE, and .50mm LE
- CORE:** Lead-Free, Lead,
- COLORS:** Black, Blue, Charcoal, Purple, Red, Teal

Size	Chest	Waist	Vest Front	Skirt
S	34-37" / 86-94 cm	28-31" / 71-79 cm	24" / 61 cm	20" / 51 cm
M	38-41" / 97-104 cm	32-35" / 81-89 cm	24" / 61 cm	22" / 56 cm
L	42-45" / 107-114 cm	36-39" / 91-99 cm	24" / 61 cm	23" / 58 cm
XL	46-49" / 117-125 cm	40-43" / 102-109 cm	24" / 61 cm	24" / 61 cm
2XL	50-52" / 127-132 cm	44-46" / 112-117 cm	24" / 61 cm	25" / 64 cm

## UFW Lightning Full Wrap

Model: UFW Color Shown: Teal



The Lightning Full Wrap offers maximum front and back partial overlap protection. Built-in slits on each side with hook and loop closures provide increased mobility. SmartTrack enabled.

- SIZE:** Small - 2xLarge
- FABRIC:** Nylon (with a double welt pocket)
- PROTECTION:** .35mm LE, and .50mm LE
- CORE:** Lead-Free, Lead,
- COLORS:** Black, Blue, Charcoal, Purple, Red, Teal

Size	Chest	Waist	Length
S	34-37" / 86-94 cm	28-31" / 71-79 cm	38" / 97 cm
M	38-41" / 97-104 cm	32-35" / 81-89 cm	38" / 97 cm
L	42-45" / 107-114 cm	36-39" / 91-99 cm	38" / 97 cm
XL	46-49" / 117-125 cm	40-43" / 102-109 cm	38" / 97 cm
2XL	50-52" / 127-132 cm	44-46" / 112-117 cm	38" / 97 cm

## UFP Lightning Front Protection

Model: UFP Color Shown: Charcoal



The Lightning Front Protection apron features side closure straps at the waist which relieve weight from the shoulders and adjust for the most comfortable fit. SmartTrack enabled.

- SIZE:** Small - 2xLarge
- FABRIC:** Nylon (with a double welt pocket)
- PROTECTION:** .35mm LE, and .50mm LE
- CORE:** Lead-Free, Lead,
- COLORS:** Black, Blue, Charcoal, Purple, Red, Teal

Size	Chest	Waist	Length
S	34-37" / 86-94 cm	28-31" / 71-79 cm	38" / 97 cm
M	38-41" / 97-104 cm	32-35" / 81-89 cm	38" / 97 cm
L	42-45" / 107-114 cm	36-39" / 91-99 cm	38" / 97 cm
XL	46-49" / 117-125 cm	40-43" / 102-109 cm	38" / 97 cm
2XL	50-52" / 127-132 cm	44-46" / 112-117 cm	38" / 97 cm



# SMART TRACK

## Track & Document Lead Apron Inspections

Manage all of your lead aprons in one place with Smart Track, the completely FREE and secure web-based garment tracking system.



### HOW IT WORKS

1. Download the free app.
2. Create your Smart Track account.
3. Add your garments.
4. Document your inspections.
5. Set inspection reminders.
6. Export and download reports.

### KEY FEATURES

- No Software & No Registration
- Garment Dashboard
- Custom Reports
- Bulk Uploads & Editing
- Filtered Search
- + More!

**TRACK ANY GARMENT**

Use your existing garment IDs or add Smart Track Retrofit Tags to any apron to get started. Smart Track Retrofit Tags feature unique IDs that can be scanned with the Smart Track App or any 2D scanner.

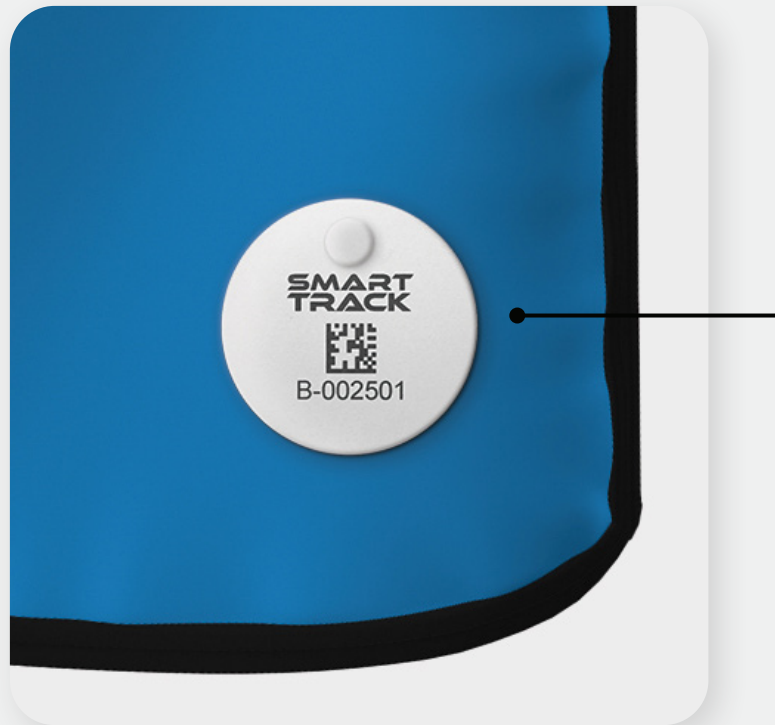

Annual Inspection Stickers



SMART TRACK Scanner



SMART TRACK 2D bar code tags with permanent security-style backing

**TESTIMONIALS**

"Smart Track makes it simple to manage my suite of lead aprons. We track over 100 aprons - it saves time and headaches."

Rich Norman – Lead Tech  
Los Robles Hospital, Thousand Oaks, CA

"Tracking lead aprons and making sure that they have been inspected is a challenge for any large radiology facility. Of the many apron-tracking systems I reviewed, I knew that the "SMART TRACK" apron inventory system would work for our facility and meet new regulatory standards set by "The Joint Commission"...The system is user friendly. All I know is that anyone who has the burden of tracking aprons needs to get "Smart" about tracking their apron inventory".

Roseann Zeldin, RT, (R) (M), CNMT – Assistant Radiation Safety Officer Department of Radiology & Imaging  
Hospital for Special Surgery New York City, New York

"The SMART TRACK Apron Inventory system has revolutionized the way lead apron quality control testing and inventory management is performed at our facility. It is a superior, comprehensive, and user-friendly product. Individual bar make tracking aprons quick and easy. It is the best system I have had the opportunity to work with."

Doug Beardsall MRT (R) CTIC – Senior Technologist QC  
Royal Victoria Regional Health Center Barrie, Ontario



[YouTube Videos](#)

Access our helpful videos on how to use the Smart Track App



**3X** Higher Breast  
Cancer Risk

Female Orthopedic Surgeons  
and Radiologic Technologists



### THE FACTS

**3X higher breast cancer** prevalence in female orthopedic surgeons

**Upper outer quadrant exposure:** 0.40 mrem/hr vs. lower inner quadrant: 0.06 mrem/hr

**C-arm positioning impact:** Lateral projection 7.5x higher exposure than AP

**Fit matters:** Improperly sized aprons increase radiation exposure



### DEVELOPED WITH DR. LINDSEY VALONE

“Our research revealed that standard aprons leave the axilla dangerously exposed—exactly where many breast cancers develop.”

Dr. Lindsey C. Valone, MD  
Research Partner & Orthopedic Surgeon

# The Under-Apron Solution



## Targeted Axillary Protection

Critical coverage for commonly exposed areas, regardless of vest size.

## Adjustable and Flexible

Customize to fit your body, ensuring protection without limiting motion.



## brrr° TRIPLE CHILL EFFECT

Integrated brrr° technology provides continuous cooling, moisture management, and rapid drying for all-day comfort.



## Your Portable Protection

Consistent axillary coverage, no matter which apron you wear.

### us UnderShield™

UnderShield™ provides targeted radiation protection for the axillary region, addressing the critical gap left by standard aprons. This innovative under-apron solution ensures comprehensive coverage for healthcare professionals working in high-radiation environments.

- Targeted axillary protection regardless of vest size
- Adjustable and flexible design for customized fit
- Exclusive brrr° cooling technology
- Moisture management and rapid drying
- Worn under existing radiation aprons
- Does not limit range of motion

Model / Size	Chest Measurement
US-XS	XS 29-32" (73.66–81.28 cm)
US-S	S 33-36" (83.8–91.4 cm)
US-M	M 37-40" (94.0–101.6 cm)
US-L	L 40-43" (101.6–109.2 cm)
US-XL	XL 44-48" (111.8–121.9 cm)
US-2XL	2XL 49-52" (124.5–132.1 cm)
US-3XL	3XL 52-55" (132.1–139.7 cm)

- MODEL NUMBERS:** US-XS, US-S, US-M, US-L, US-XL, US-2XL, US-3XL
- SIZES:** XS, S, M, L, XL, 2XL, 3XL
- INNER MATERIAL:** Exclusive brrr° cooling technology
- COVERAGE:** Targeted axillary protection
- APPLICATION:** Worn under existing aprons
- COMFORT:** Cooling, moisture-wicking, rapid drying
- PROTECTION:** Lead Free (Each panel 0.25 mm LE, 0.50 mm LE where overlapped)

## REV-TC Revolution Thyroid Collar

- SIZES:** One size fits most
- COLORS:** 500 Series, 600 Series, 700 Series, 800 Series, 900 Series, Remix
- CORE:** Lead, Lead-Free
- CLOSURE:** Hook and Loop Closure, Buckle

- Large coverage area
- Exclusive Revolution outer fabric
- Brrr° Cooling Interior Fabric
- Optional monogram
- Optional KTC attachment



## TCV Thyroid Collar with Binding

- SIZES:** X-Small, Standard, Medium
- COLORS:** Revolution 700 series & All Classic Nylon Colors
- CORE:** Lead, Lead-Free
- CLOSURE:** Hook and Loop Closure, Buckle or Magnet

- Comfortable fit
- Large protection area
- Optional monogram
- Optional KTC attachment

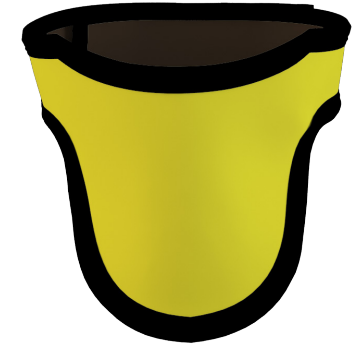

## SVT Visor Style Thyroid Collar

- SIZES:** X-Small, Standard, Medium
- COLORS:** All
- CORE:** Lead, Lead-Free
- CLOSURE:** Hook and Loop Closure, Buckle

- Comfortable fit
- Large coverage area
- Optional monogram
- Optional KTC attachment

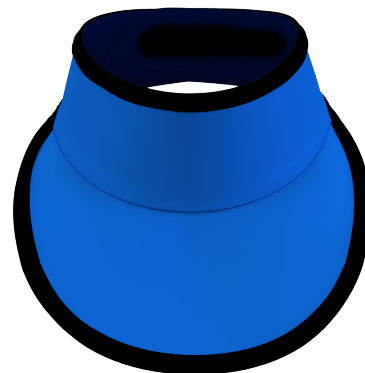

## MTC Magnetic Thyroid Collar

- SIZES:** X-Small, Standard, Medium
- COLORS:** All
- CORE:** Lead, Lead-Free
- CLOSURE:** Magnet

- Comfortable fit
- Large coverage area
- Optional monogram
- Optional KTC attachment





**NST** Thyroid Collar Without Binding

- SIZES:** X-Small, Standard, Medium
- COLORS:** Revolution 700 Series & All Classic Nylon Colors
- CORE:** Lead, Lead-Free
- CLOSURE:** Hook and Loop Closure, Buckle, Magnet

- Comfortable fit
- Large protection area
- Optional monogram
- Optional KTC attachment



**KTC** Attachment Options



KTC Buckle



KTC Key Ring



KTC No Buckle



KTC attachment is now securely positioned on the shoulder of all Revolution aprons.

**300102** Thyroid Collar Cover



- Keeps thyroid collars sanitary and clean
- Attaches easily to NST-S1 & TCV-S1 collars
- Easy to wash or replace when soiled
- Revolution 700 Series & All Classic nylon colors
- Can be monogrammed for personalization and easy identification



Protects NST-S1 & TCV-S1

## NSM Non-Slip Material for Skirts

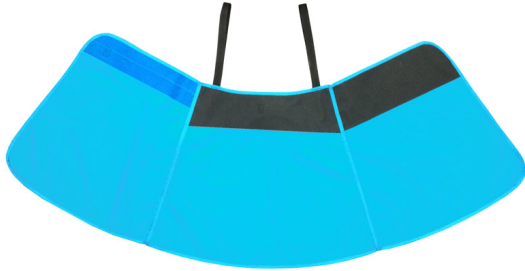

- Prevents your INFAB skirt from slipping down the waist and causing discomfort
- Can be added to any INFAB skirt by adding part number NSM

## Shin Guards



- Reduce radiation exposure to the shins
- Hook and loop closures for easy adjustments

**COLORS:** Classic nylon colors

**SIZES:** Small, Medium, Large

**CORE:** Lead, Lead-Free

## REV-BAG Revolution Apron Bag



- Revolution fabric
- Plastic bottom to prevent sagging
- Opening on top of bag
- Zipper across the top of bag



## 909821 Apron Bag



- Classic nylon color options
- Classic tube style design
- Opening on side of bag
- Plastic handle on top of bag



**REV-SLV-1** Revolution Attached Thyroid Collar Sleeves

- Revolution outer fabric
- Additional protection for chest
- Wear under any apron

**COLORS:** Revolution 700 Series  
**SIZES:** Small, Medium, Large, X-Large, XX-Large  
**CORE:** Lead, Lead-Free



FRONT



BACK

**REV-SLV-2** Revolution Sleeve Individual

- Revolution outer fabric
- Hook and loop closure elastic strap for easy on/off convenience
- One per order

**COLORS:** Revolution 700 Series  
**CORE:** Lead, Lead-Free





**SLV** Optional Left or Right Sleeve

- Added protection of the arm and shoulder
- .50mm LE
- Available on most INFAB apron models
- Optional removable snap on, permanent sewn on or hook and loop closure attached configuration

**COLORS:** Revolution 700 Series & All Classic Nylon Colors

**ATTACHED:** Sewn on, snaps or hook and loop closure

**CORE:** Lead, Lead-Free



**APW** Axillary Protection Wings

Increase the protection to your axillary region without sacrificing any mobility or adding weight to your apron.

**COLORS:** Revolution 700 Series & All Classic Nylon Colors

**CORE:** Lead, Lead-Free



**257890** Suspenders

- Fully adjustable suspenders with a handy snap on style.
- One size fits all.

**The Original Black Belt®**

The Black Belt® is a 6" wide orthopedic elastic belt that supports your lower back while removing the weight of the apron from your shoulders. Optional KTC Buckle Attachment and/or side snaps.

**COLORS:** Black

**SIZES:** X-Small, Small, Medium, Large, X-Large, XX-Large

**257879** 6" Black Belt® - X-Small

**257880** 6" Black Belt® - Small

**257881** 6" Black Belt® - Medium

**257882** 6" Black Belt® - Large

**257883** 6" Black Belt® - X-Large

**257884** 6" Black Belt® - XX-Large





### Revolution Elastic Back Thinking Cap

- Revolution outer fabric
- Scatter radiation protection
- Brrr° Cooling Interior Fabric
- Elastic-back for easy on/off convenience

**SIZE:** Small, Medium, Large, X-Large, XX-Large  
**COLORS:** 700 Series Revolution Colors  
**PROTECTION:** .25mm LE, .35mm LE, .50mm LE  
**CORE:** Lead, Lead-Free



### Classic Thinking Cap with Tie Straps

- Classic nylon colors
- Head and skull radiation protection
- Scatter radiation protection
- Brrr° Cooling Interior Fabric

**SIZE:** Small, Medium, Large, X-Large, XX-Large  
**COLORS:** Classic Nylon Colors  
**PROTECTION:** .25mm LE, .35mm LE, .50mm LE  
**CORE:** Lead, Lead-Free



### 400025 Revolution Hook and Loop Closure Back Thinking Cap

- Revolution outer fabric
- Scatter radiation protection
- Brrr° Cooling Interior Fabric
- Hook & loop back closure for customizable fit

**SIZE:** One Size Fits All  
**COLORS:** 700 Series Revolution Colors  
**PROTECTION:** .25mm LE, .35mm LE, .50mm LE  
**CORE:** Lead, Lead-Free

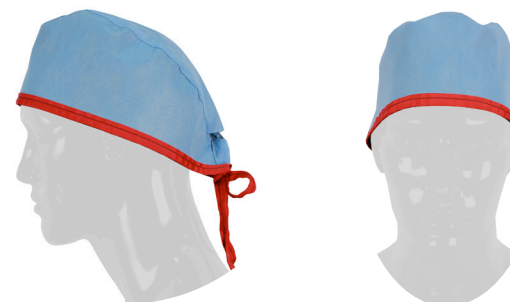

### DC-25 Lead-Free Disposable Thinking Cap

- Quantity 20/Case
- .25mm LE
- Adjusts to fit all head sizes
- For use by all personnel during any interventional procedure
- 100% lead free for easy disposal

**SIZE:** One Size Fits All  
**COLORS:** Scatter Armor Blue  
**PROTECTION:** .25mm LE  
**CORE:** Lead-Free



## PARTNERING TO KEEP YOUR APRONS CLEAN & SAFE

INFAB is proud to be a global cleaning solutions partner with Clorox.



### Excellent product aesthetics

- No harsh chemical odor or fumes
- No fragrance added
- Nonflammable, unlike quaternary ammonium-alcohol-based wipes
- No volatile organic compounds (VOCs)

### Broad healthcare surface compatibility

Recommended for plastics and laminated surfaces, whereas isopropyl alcohol will attack some forms of plastic, rubber and coatings\*

Surface materials: All INFAB aprons, stainless steel, vinyl, glass, baked enamel, chrome, glazed tile, glazed ceramic, glazed porcelain, porcelain enamel, laminated surfaces, plastic

If light residue appears, it can easily be removed with a clean, damp cloth

Pictures of 1 ft <sup>2</sup> Infab apron surfaces after treated with 120 product applications over a 10-week period.			
Clorox Healthcare <sup>®</sup> Hydrogen Peroxide Cleaner Disinfectant Wipes			
			
Revolution Fabric	Brr <sup>®</sup> Interior Fabric	Standard Nylon	Diamond Ripstop

\* Based on 30-second non-TB, non-Staphylococcus epidermidis bacteria and virus contact times for general disinfecting on federal master labels as of 2/14/13.



**683447** Revolution Scrubbles Apron Cleaner

Scrubbles apron cleaner safely cleans your aprons of barium, blood and other common radiology related stains. Now with a clean citrus scent and a stronger more efficient formula.

**SIZE** 32 oz

**Also Available**  
**683448**  
 Case of 12 32 oz bottles with Spray Caps



**CLX28** Clorox Spray

Recommended for:  
 Multipurpose use on hard and soft surfaces

**SIZE** 32 oz



**CLX24**  
 Clorox Multipurpose Wipes

Recommended for: Everyday cleaning and disinfecting, daily patient room cleaning, hard, high-touch surfaces

**SIZE** 6.75" x 9"

**QTY** 95 ct

# SCATTER RADIATION SAFETY

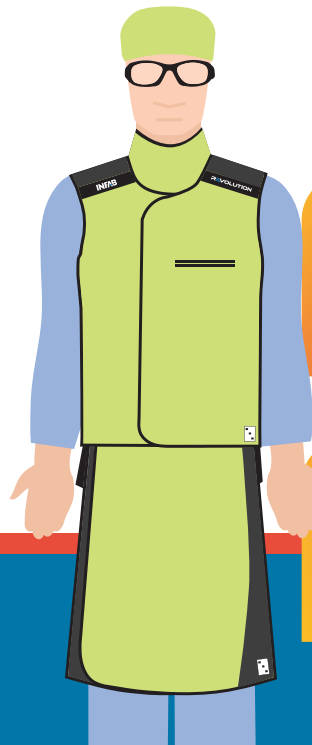

## Chest Exposure

SCATTER ARMOR  
Reduces Chest Exposure  
**55-80%**

## Hand Exposure

SCATTER ARMOR  
Reduces Hand Exposure  
**>49%**



**SCATTER  
ARMOR**

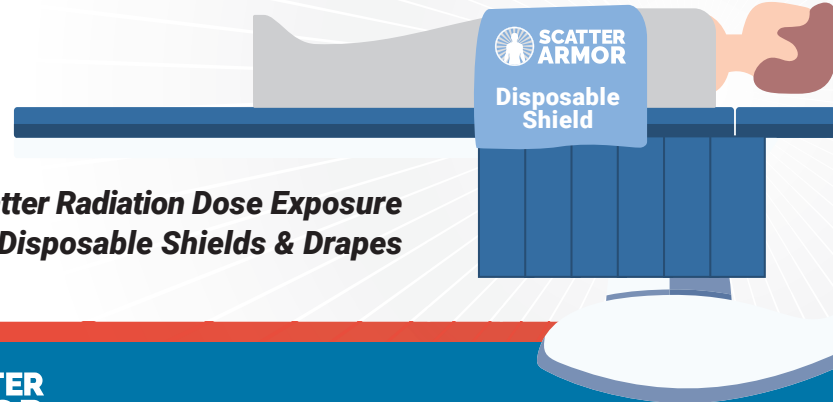

**Reduce Scatter Radiation Dose Exposure  
with Disposable Shields & Drapes**



**Protective Core  
Material Inside:**



*"The scattered radiation from the patient comprises the main source of radiation dose to staff."*

### Scatter protection

Shields provide scatter radiation protection for radial and many other types of procedures. Our lead-free material is the most protective core material against scatter radiation.

### How it works

Sterile Scatter Armor Shields are placed on top of the patient drape to block scatter radiation at the source, creating a scatter-free zone, reducing harmful radiation exposure to the doctor or clinician.

### One-time use

Scatter Armor Shields are lead-free and disposable.

### Sterile

Packaged individually in sterile packets.

### Flexible

Scatter Armor Shields easily mold to the patients body for ease of use and maximum protection

### Scatter Radiation Testing

#### ASTM Test Method F2547-18.12 14.2.3 Test Results

Sample Information	80 kVp	90 kVp	100 kVp	110 kVp
Scatter Armor Shield Lead Free 0.25mm LE	91.0%	90.0%	86.8%	85.9%

### Absorbent

Scatter Armor Shields utilize the highest absorbency covering material in the industry, critical in heavy fluid situations.

Absorbent Rate	1.3 sec
Weight	2.36 osy / 80 gsm
Absorbent Capacity	686% 16.2osy / 549 gsm

GSM - Grams per square meter, OSY - Ounce per square yard

### Scatter Armor Multipurpose Shield

Transradial Access: Left and Right Radial, Shunt, Biliary Drainage, Spinal, Fibroid Embolization

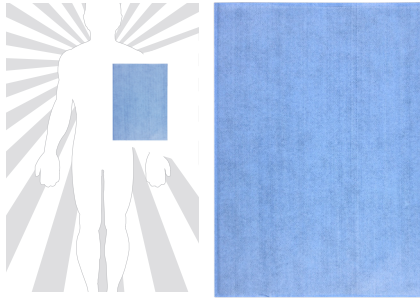

### Scatter Armor Angiography Shield

Transfemoral Access: Angiography, Coronary Catheterization

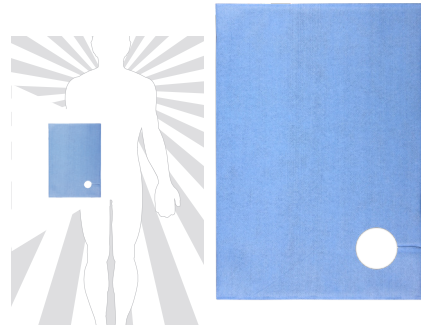

### Scatter Armor Biliary Split Shield

Biopsy Procedures, Transjugular Intrahepatic Portosystemic Shunt (TIPS)

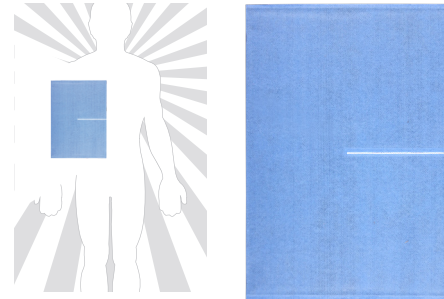

### Scatter Armor Peripheral Shield

Peripheral procedures where the access is through the femoral Artery.

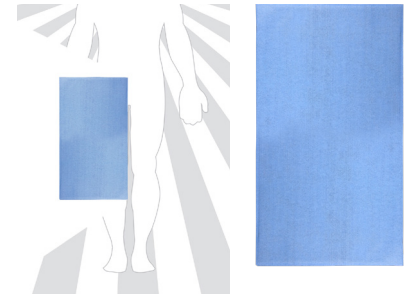

### Scatter Armor Multipurpose Shield with Fenestration

Needle Biopsy or Puncture Procedures.

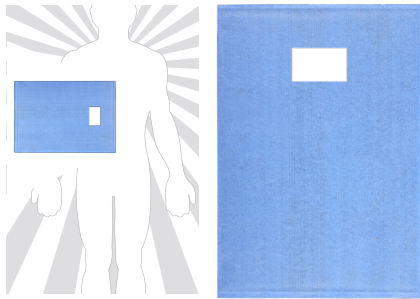

### Scatter Armor EP Shield

Subclavian Access: Bi-Ventricular Pacemaker Implants, ICS procedures, and Bi-Ventricular Pacing.

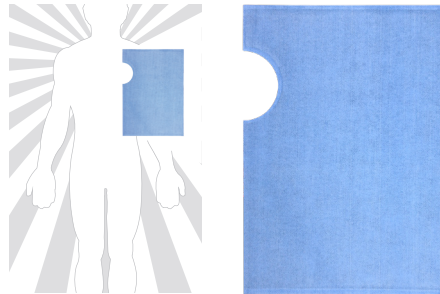

### Scatter Armor Dialysis Drape

Dialysis Access and Declothing Procedures.

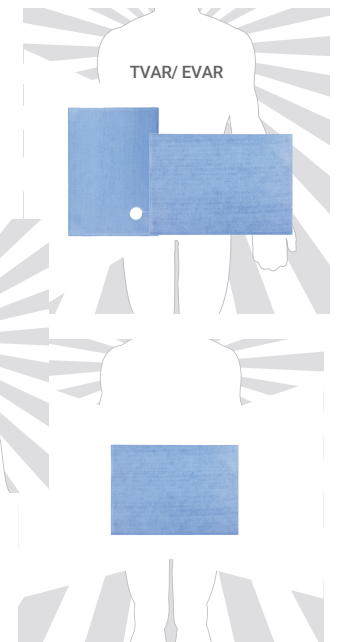
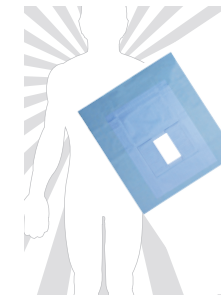
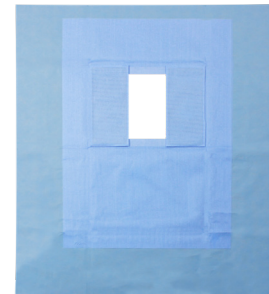

#### Scatter Armor Shields

Scatter Armor Multi-Purpose Shield, Absorbent, No Fenestration Box	SA-MPS	Box of 15
Scatter Armor Multi-Purpose Shield, Absorbent, No Fenestration Case	SA-MPS-CS	Case of 45
Scatter Armor Multi-Purpose Shield with Fenestration, Absorbent, Rectangular Fenestration Box	SA-MPF	Box of 15
Scatter Armor Multi-Purpose Shield with Fenestration, Absorbent, Rectangular Fenestration Case	SA-MPF-CS	Case of 45
Scatter Armor EP Shield, Absorbent, Scoop Fenestration Box	SA-EPS	Box of 15
Scatter Armor EP Shield, Absorbent, Scoop Fenestration Case	SA-EPS-CS	Case of 45
Scatter Armor Angiography Shield, Absorbent, Circular Fenestration Box	SA-AGS	Box of 15
Scatter Armor Angiography Shield, Absorbent, Circular Fenestration Case	SA-AGS-CS	Case of 45
Scatter Armor Biliary Split Shield, Absorbent, Center Slit Fenestration Box	SA-BSS	Box of 15
Scatter Armor Biliary Split Shield, Absorbent, Center Slit Fenestration Case	SA-BSS-CS	Case of 45
Scatter Armor Dialysis Drapes Box	SA-DDD	Box of 10
Scatter Armor Dialysis Drapes Case	SA-DDD-CS	Case of 30
Scatter Armor Peripheral Shield, Absorbent, No Fenestration Box	SA-PER	Box of 10
Scatter Armor Peripheral Shield, Absorbent, No Fenestration Case	SA-PER-CS	Case of 30

Part Number	Unit
SA-MPS	Box of 15
SA-MPS-CS	Case of 45
SA-MPF	Box of 15
SA-MPF-CS	Case of 45
SA-EPS	Box of 15
SA-EPS-CS	Case of 45
SA-AGS	Box of 15
SA-AGS-CS	Case of 45
SA-BSS	Box of 15
SA-BSS-CS	Case of 45
SA-DDD	Box of 10
SA-DDD-CS	Case of 30
SA-PER	Box of 10
SA-PER-CS	Case of 30

## C-ARM DRAPES

### 1001 - C Arm Drape



This item fits all full-size C Arms. Made from durable, high quality polyethylene materials with abrasion resistance to protect from rips or tears.

- HIGHLIGHTS:** CE Certified, Sterile Product, and Latex Free
- QUANTITY:** 30 Drapes (15 drapes per box, 2 boxes included)
- DIMENSIONS:** 42" x 72"
- PACKING SIZE:** 6" x 12" x 17"
- TOTAL WEIGHT:** 13.3 lbs.

### 1002 - C Arm Kit



Contains C-Arm drape, gray Foot Switch Cover, Image Intensifier and X-ray Tube Cover. Fits OEC® 9600/9800/9900 matches OEC® part #00-901501-01 and E9100AG. Includes 5 mounting clips. Made from durable, high quality polyethylene materials with abrasion resistance to protect from rips or tears.

- HIGHLIGHTS:** Sterile Product, and Latex Free
- QUANTITY:** 20 Drapes per box
- DIMENSIONS:** Multiply Dimensions in this Kit
- PACKAGING SIZE:** 7" x 21" x 24"
- TOTAL WEIGHT:** 16.7 lbs.

### 4003 - 54" x 63" Mini C Arm Drape



Fits mini-size C Arms, Xi-Scan, Fluoroscanner 3" or 4" FOV. Made from durable, high quality polyethylene materials with abrasion resistance to protect from rips or tears.

- HIGHLIGHTS:** Sterile Product and Latex Free
- QUANTITY:** 40 Drapes (20 drapes per box, 2 boxes included)
- DIMENSIONS:** 54" x 63"
- PACKAGING SIZE:** 10" x 17" x 24"
- TOTAL WEIGHT:** 18 lbs.

### 8003/5406 - Foot Switch Cover



Foot Switch Cover that is clear and fits with Cinch Lock. Made from durable, high quality polyethylene materials with abrasion resistance to protect from rips or tears.

- HIGHLIGHTS:** Sterile Product, and Latex Free
- QUANTITY:** 100 per box
- DIMENSIONS:** 17" x 15"
- PACKAGING SIZE:** 10" x 14" x 22"
- TOTAL WEIGHT:** 8 lbs.

# Cassette Covers

## Protect Your Cassettes

COMPLETE, HIGHLY EFFECTIVE PROTECTION FROM CONTAMINATION



14" x 17"



16" x 19"



24" x 20"

INFAB offers our Cassette Covers in a variety of standard sizes to perfectly fit your needs.

Protect your cassettes in our simple and convenient INFAB Cassette Covers.

Available in boxes of 100 or cases of 500 in an easy-to-use dispenser box.

Cassettes come in contact with blood and other potentially infectious materials.

- Protect your cassettes from cross-contamination
- Protect your patients from infection
- Specially designed to fit your X-ray cassettes
- For use in any imaging area where a risk of contamination exists.

IN-STOCK SAME-DAY SHIPPING

Help Stop the Spread of Infection



The Centers for Disease Control and Prevention (CDC) estimates that roughly 1.7 million hospital-associated infections, from all types of bacteria combined, cause or contribute to 99,000 deaths each year.<sup>1</sup>

<sup>1</sup> Klevens RM, Edwards JR, Richards CL, et al. (2007). "Estimating health care-associated infections and deaths in U.S. hospitals, 2002". Public Health Rep 122 (2): 160–6. PMID 17357358.

<sup>2</sup> Scott II, R. Douglas, (2009). "The Direct Medical Costs of Healthcare-Associated Infections in U.S. Hospitals and the Benefits of Prevention". National Center for Preparedness, Detection, and Control of Infectious Diseases

### Zip Top Cassette Covers

BOX OF 100/500



Zip Top



- Zip top
- Packed in handy dispenser boxes
- 100 or 500 individual covers per box
- Available in the five cassette sizes
- Always in stock
- Impervious to fluids
- Available in money saving cases of 500.

- Easy to use
- High quality
- Sanitary
- Disposable
- Top grade polyethylene plastic

Model	Description	Dimensions	Fits Cassette Size
911417-ZT	Cassette Cover Zip Top Disposable Box of 100	17" x 19.875"	14" X 17"
901417-ZT	Cassette Cover Zip Top Disposable Box of 500	17" x 19.875"	14" X 17"
911619-ZT	Cassette Cover Zip Top Disposable Case of 100	19.25" x 22.25"	16" x 19"
901619-ZT	Cassette Cover Zip Top Disposable Case of 500	19.25" x 22.25"	16" x 19"
912420-ZT	Cassette Cover Zip Top Disposable Case of 100	20" x 24.625"	24" x 20"
902420-ZT	Cassette Cover Zip Top Disposable Case of 500	20" x 24.625"	24" x 20"

### Flip Top Cassette Covers

BOX OF 100/500



Sandwich bag style flap

- "Sandwich" bag style flap
- Packed in handy dispenser boxes
- 100 or 500 individual covers per box
- Available in the five cassette sizes
- Always in stock
- Impervious to fluids
- Available in money saving cases of 500.

- Easy to use
- High quality
- Sanitary
- Disposable
- Top grade polyethylene plastic

Model	Description	Dimensions	Fits Cassette Size
911417	Cassette Cover Disposable Box of 100	17" x 19.875"	14" X 17"
901417	Cassette Cover Disposable Case of 500	17" x 19.875"	14" X 17"
911619	Cassette Cover Disposable Box of 100	19.25" x 22.25"	16" x 19"
901619	Cassette Cover Disposable Case of 500	19.25" x 22.25"	16" x 19"
912420	Cassette Cover Disposable Case of 100	20" x 24.625"	24" x 20"
902420	Cassette Cover Disposable Case of 500	20" x 24.625"	24" x 20"

Cassette Covers Roll & Rack and Wall Mounted Rack Available on [www.infabcorp.com](http://www.infabcorp.com).



# From Finish Line to Frontline: INFAB's Radiation Protection Glasses

## PRESCRIPTION

We offer plano, single vision, bifocal, and bifocal progressive options.

## PROTECTION

All glasses have lead protection.  
\* Varies per model

## FRAMES

Wide variety of frames from top designers for all face shapes.

## PERSONALIZE

Engrave a name, initials, phone number, or date.



CROSSLINK-01  
Matte Black

Lens Width: 54mm



Bridge Width: 20mm



Temple Length: 135mm



## Oakley Crosslink Zero

The Oakley Crosslink Zero lead glasses have fixed temples with a three-Point Fit to ensure lenses are aligned for visual correction. Wire cores hidden inside the temples of this lightweight frame offer adjustability for a perfect fit.

- Rubberized Nosepads and Ear socks for comfort
- Lightweight O Matter™ Frame

**FRAME SIZE:** Universal

**WEIGHT:** 61.6g

**PRESCRIPTION:** Plano, Single Vision, Most Bi-Focal & Bi-Focal Progressive

**COLORS:** Matte Black

**PROTECTION:** .75mm LE

**INCLUDES:** Anti-fog spray, safety strap add-on, protective case



## Oakley Jupiter Squared

The sporty Jupiter Squared is attitude with refinement. The handles of switchblade knives inspired the earstems and their metal bands and rivets. The Matte Black frames of the Flag Collection are highlighted with American flag emblems.

- Rubberized Earsocks for comfort and grip
- USA flag logo on temple arms
- Lightweight O Matter™ Frame

**FRAME SIZE:** Universal

**WEIGHT:** 74.1g

**PRESCRIPTION:** Plano, Single Vision, Most Bi-Focal & Bi-Focal Progressive

**COLORS:** Matte Black

**PROTECTION:** .75mm LE

**INCLUDES:** Anti-fog spray, safety strap add-on, protective case



JUPITER-01  
Matte Black

Lens Width: 56mm



Bridge Width: 18mm



Temple Length: 135mm



## GLASSES



7177-01  
Cacao/Pink Foam Gradient



7177-02  
Blue/Peach Gradient

### NIKE - 7177

The Nike 7177 radiation protection glasses combine ultra-lightweight construction in high quality acetate with 0.75mm lead equivalency lenses. These glasses deliver optimal stability and comfort during long medical procedures, perfect for professionals who value both style and function.

- FRAME SIZE:** Universal
- WEIGHT:** 67 g
- PRESCRIPTION:** Plano, Single Vision, Most Bi-Focal & Bi-Focal Progressive
- COLORS:** Cacao/Pink Foam Gradient, Blue/Peach Gradient
- PROTECTION:** .75mm LE
- INCLUDES:** Anti-fog spray, safety strap add-on, protective case

Lens Width: 53mm

Bridge Width: 17mm

Temple Length: 140mm

Lens Height: 39.5mm

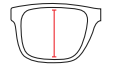
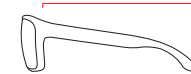
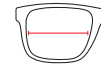

### NIKE - Temper Flair

The Nike Temper Flair INFAB radiation protection glasses feature a sophisticated square frame design with 0.75mm lead equivalency lenses for medical professionals. The durable acetate construction and precise single bridge design ensure long-lasting comfort during extended medical procedures.

- FRAME SIZE:** Universal
- WEIGHT:** TEMPERFLAIR-01 - 68 g  
TEMPERFLAIR-02 - 66 g  
TEMPERFLAIR-03 - 68 g
- PRESCRIPTION:** Plano, Single Vision, Most Bi-Focal & Bi-Focal Progressive
- COLORS:** Washed Coral/Mauve, Vintage Green, Taupe Grey/Teal
- PROTECTION:** .75mm LE
- INCLUDES:** Anti-fog spray, safety strap add-on, protective case



TEMPERFLAIR-01  
Washed Coral/Mauve



TEMPERFLAIR-02  
Vintage Green



TEMPERFLAIR-03  
Taupe Grey/Teal

Bridge Width: 18mm

Temple: 140mm

Lens Width: 53mm

Lens Height: 41.4mm

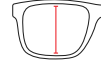
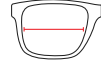
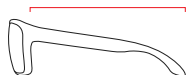



7405-01  
Matte Black



7405-02  
Matte Obsidian



7405-03  
Matte Vintage Green

**NIKE - 7405**

The Nike 7405 INFAB radiation protection glasses offer a modern angular design with rubberized temple tips for secure fit, featuring 0.75mm lead equivalency lenses in a durable matte-finish frame for essential medical radiation protection.

- FRAME SIZE:** Universal
  - WEIGHT:** 7405-01 - 60 g  
7405-02 - 62 g  
7405-03 - 60 g
  - PRESCRIPTION:** Plano, Single Vision, Most Bi-Focal & Bi-Focal Progressive
  - COLORS:** Matte Black, Matte Obsidian, Matte Vintage Green
  - PROTECTION:** .75mm LE
  - INCLUDES:** Anti-fog spray, safety strap add-on, protective case
- Lens Width: 56mm      Bridge Width: 18mm      Temple Length: 145mm      Lens Height: 37mm



**NIKE - 7160**

The Nike 7160 INFAB radiation protection glasses feature a lightweight rectangular design with flexing spring-loaded hinges and texturized rubber temple tips that stay put without pinching. These glasses incorporate 0.75mm lead equivalency lenses while maintaining optimal comfort and a secure fit that complements round and wide face shapes.

- FRAME SIZE:** Universal
- WEIGHT:** 72 g
- PRESCRIPTION:** Plano, Single Vision, Most Bi-Focal & Bi-Focal Progressive
- COLORS:** Clear Forest  
Crystal Midnight Navy
- PROTECTION:** .75mm LE
- INCLUDES:** Anti-fog spray, safety strap add-on, protective case



7160-01  
Clear Forest



7160-02  
Crystal Midnight Navy





7015-02  
Matte Black/Space Blue

**NIKE - 7015**

The Nike 7015 INFAB radiation protection glasses combine a classic rectangular acetate frame with 0.75mm lead equivalency lenses, featuring a comfortable single bridge design and durable hinges perfect for healthcare professionals.

FRAME SIZE:	Universal
WEIGHT:	65 g
PRESCRIPTION:	Plano, Single Vision, Most Bi-Focal & Bi-Focal Progressive
COLORS:	Matte Black/Space Blue
PROTECTION:	.75mm LE
INCLUDES:	Anti-fog spray, safety strap add-on, protective case

Lens Width: 55mm

Bridge Width: 17mm

Temple Length: 145mm

Lens Height: 38.1mm

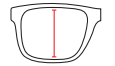
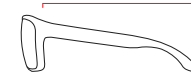

**NIKE - Radeon 3 LB**

The Nike Radeon 3 LB INFAB radiation protection glasses feature a modern square-shaped frame with a single bridge design and 0.75mm lead equivalency lenses, delivering essential protection in a sporty, unisex style. If standard glasses typically slip down your nose or rest on your cheeks, the Low Bridge design features a modified nose pad for a closer fit.

FRAME SIZE:	Universal
WEIGHT:	RADEON3LB-01 - 80 g RADEON3LB-02 - 81 g
PRESCRIPTION:	Plano, Single Vision, Most Bi-Focal & Bi-Focal Progressive
COLORS:	Shiny Black/Grey Clear Blue
PROTECTION:	.75mm LE
INCLUDES:	Anti-fog spray, safety strap add-on, protective case



RADEON3LB-01  
Shiny Black/Grey



RADEON3LB-02  
Clear Blue

Bridge Width: 18mm

Temple: 145mm

Lens Width: 55mm

Lens Height: 44.6mm

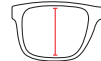
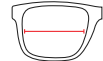
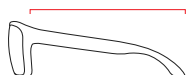



7116-02  
Matte Dark Grey - Black



7116-03  
Matte Gridiron - Pacific Blue



7116-04  
Matte Black - Space Blue

**NIKE - 7116**

Rubber nose pad and temple tip inlays designed to become tackier as the skin perspires for a strong and secure eyewear fit. Core wire memory metal temple tips for on the fly eyewear adjustability and grip. Lightweight, durable nylon frame

- FRAME SIZE:** Universal
- WEIGHT:** 57G
- PRESCRIPTION:** Plano, Single Vision, Most Bi-Focal & Bi-Focal Progressive
- COLORS:** Matte Dark Grey - Black, Matte Gridiron - Pacific Blue, Matte Black - Space Blue
- PROTECTION:** .75mm LE
- INCLUDES:** Anti-fog spray, safety strap add-on, protective case

Lens Width: 56.1mm

Bridge Width: 15mm

Temple Length: 140mm

Lens Height: 38.8mm

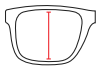
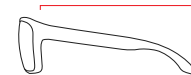
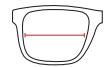



7118-04  
Matte Midnight Navy - Wolf Grey

**NIKE - 7118**

Rubber nosepad and temple tip inlays designed to become tackier as the skin perspires for a strong and secure eyewear fit. Core wire memory metal temple tips for on the fly eyewear adjustability and grip. Lightweight, durable nylon frame

- FRAME SIZE:** Universal
- WEIGHT:** 54G
- PRESCRIPTION:** Plano, Single Vision, Most Bi-Focal & Bi-Focal Progressive
- COLORS:** Matte Midnight Navy - Wolf Grey
- PROTECTION:** .75mm LE
- INCLUDES:** Anti-fog spray, safety strap add-on, protective case

Lens Width: 55mm      Bridge Width: 14mm      Temple Length: 140mm      Lens Height: 36.5mm



**NIKE - 7284**

Nike 7284 is a full rim, progressive eligible frame for men and women made of injected plastic. This model features a rounded edges shape, a single bridge, and durable hinges.

- FRAME SIZE:** Universal
- WEIGHT:** 57G
- PRESCRIPTION:** Plano, Single Vision, Most Bi-Focal & Bi-Focal Progressive
- COLORS:** Brown Basalt - Clear Fade, Clear - Cool Grey
- PROTECTION:** .75mm LE
- INCLUDES:** Anti-fog spray, safety strap add-on, protective case

Bridge Width: 16mm      Temple: 145mm      Lens Width: 54mm      Lens Height: 39mm



7284-01  
Brown Basalt - Clear Fade



7284-02  
Clear - Cool Grey

**NIKE - 7286-02**

Nike 7286 is a full rim, progressive eligible frame for men and women made of eco-friendly plastic, bio acetate. This model features a rectangular shape with a single bridge featuring durable hinges.



7286-02  
Matte Obsidian - Blue

- FRAME SIZE:** Universal
- WEIGHT:** 68G
- PRESCRIPTION:** Plano, Single Vision, Most Bi-Focal & Bi-Focal Progressive
- COLORS:** Matte Obsidian - Blue
- PROTECTION:** .75mm LE
- INCLUDES:** Anti-fog spray, safety strap add-on, protective case

Lens Width: 56.1mm    Bridge Width: 15mm    Temple Length: 140mm    Lens Height: 38.8mm



**NIKE - Adrenaline 22**

The Adrenaline 22 Nike frame feature a ventilated rubber nose bridge to reduce fogging. In addition, secure wrap temples provide stability, comfort, and added grip. Durable, no-screw hinges stay securely open and closed.

- FRAME SIZE:** Universal
- WEIGHT:** 68G
- PRESCRIPTION:** Plano, Single Vision, Most Bi-Focal & Bi-Focal Progressive
- COLORS:** Matte Black - Volt, Matte Black - Grey
- PROTECTION:** .75mm LE
- INCLUDES:** Anti-fog spray, safety strap add-on, protective case

Lens Width: 64mm    Bridge Width: 15mm    Temple Length: 130mm    Lens Height: 40.4mm



ADRENALINE22-03  
Matte Black - Grey



ADRENALINE22-02  
Matte Black - Volt

# GLASSES



BRAZEN-02  
Matte Black - Military Blue



BRAZEN-04  
Shiny Black

## NIKE - Brazen

The Nike Brazen glasses combine streamlined style, comfort and lightweight durability. They feature a nylon frame and ventilated nose bridge. The Brazen is our most popular model.

- FRAME SIZE:** Universal
- WEIGHT:** 77G
- PRESCRIPTION:** Plano, Single Vision, Most Bi-Focal & Bi-Focal Progressive
- COLORS:** Matte Black- Military Blue, Shiny Black
- PROTECTION:** .75mm LE
- INCLUDES:** Anti-fog spray, safety strap add-on, protective case

Lens Width: 60.5mm

Bridge Width: 16mm

Temple Length: 135mm

Lens Height: 37.5mm

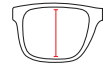
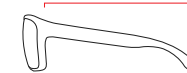
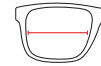

## NIKE - Brazen Fury

Rubber nosepad and temple tip inlays designed to become tackier as the skin perspires for a strong and secure eyewear fit. Core wire memory metal temple tips for on the fly eyewear adjustability and grip. Lightweight, durable nylon frame

- FRAME SIZE:** Universal
- WEIGHT:** 82G
- PRESCRIPTION:** Plano, Single Vision, Most Bi-Focal & Bi-Focal Progressive
- COLORS:** Matte Dark Grey - Silver Flash, Matte Midnight Navy, Matte Black - White Red
- PROTECTION:** .75mm LE
- INCLUDES:** Anti-fog spray, safety strap add-on, protective case

Lens Width: 61mm

Bridge Width: 18mm

Temple Length: 130mm

Lens Height: 43.5mm

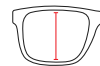
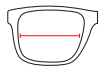

BRAZENFURY-01  
Matte Dark Grey - Silver Flash



BRAZENFURY-02  
Matte Black - White Red



BRAZENFURY-03  
Matte Midnight Navy



BRAZENSADOW-01  
Matte Anthracite - Grey



BRAZENSADOW-02  
Matte Dark Grey - Red

**NIKE - Brazen Shadow**

The Nike Brazen Shadow features a rubber nose pad and temple tip inlays designed to become tackier as the skin perspires for a solid and secure eyewear fit. Core wire memory metal temple tips provide on-the-fly eyewear adjustability and grip.

- FRAME SIZE:** Universal
- WEIGHT:** 60G
- PRESCRIPTION:** Plano, Single Vision, Most Bi-Focal & Bi-Focal Progressive
- COLORS:** Matte Anthracite - Grey, Matte Dark Grey - Red
- PROTECTION:** .75mm LE
- INCLUDES:** Anti-fog spray, safety strap add-on, protective case

Lens Width: 59mm      Bridge Width: 16mm      Temple Length: 130mm      Lens Height: 37.4mm



**NIKE - Maverick**

The Nike Maverick glasses are pure performance on the inside. The lightweight frame features ventilation and temple arms that provide a soft, firm grip, ensuring you can wear these for hours at a time.

- FRAME SIZE:** Universal
- WEIGHT:** 78G
- PRESCRIPTION:** Plano, Single Vision, Most Bi-Focal & Bi-Focal Progressive
- COLORS:** Matte Midnight Navy, Matte Cool Grey, Matte Black Red
- PROTECTION:** .75mm LE
- INCLUDES:** Anti-fog spray, safety strap add-on, protective case

Lens Width: 59mm      Bridge Width: 15mm      Temple Length: 145mm      Lens Height: 45.3mm



MAVERICK-04  
Matte Midnight Navy



MAVERICK-03  
Matte Cool Grey

## GLASSES



MAVERICKRGE-03  
Matte Midnight Navy Silver Flash



MAVERICKRGE-02  
Matte Black-Grey



MAVERICKRGE-01  
Matte Black-Green

## NIKE - Maverick RGE

The Nike Maverick RGE sunglasses continue the Maverick legacy with long-wearing comfort and a flexible fit in an updated shape. Full rubber nosebridge and temple tips designed to become tackier as the skin perspires for a strong and secure fit.

- FRAME SIZE:** Universal
- WEIGHT:** 78G
- PRESCRIPTION:** Plano, Single Vision, Most Bi-Focal & Bi-Focal Progressive
- COLORS:** Matte Midnight Navy- Silver Flash, Matte Black-Grey, Matte Black-Green
- PROTECTION:** .75mm LE
- INCLUDES:** Anti-fog spray, safety strap add-on, protective case

Lens Width: 59mm

Bridge Width: 15mm

Temple Length: 145mm

Lens Height: 40.4mm

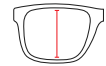
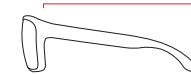

## NIKE - Premier

Rubber nosepad and temple tip inlays designed to become tackier as the skin perspires for a strong and secure fit.

- FRAME SIZE:** Universal
- WEIGHT:** 64G
- PRESCRIPTION:** Plano, Single Vision, Most Bi-Focal & Bi-Focal Progressive
- COLORS:** Matte Black, Matte Anthracite - Grey
- PROTECTION:** .75mm LE
- INCLUDES:** Anti-fog spray, safety strap add-on, protective case

Lens Width: 60mm

Bridge Width: 13mm

Temple Length: 135mm

Lens Height: 39.3mm

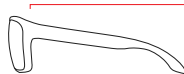

PREMIER-07  
Matte Black



PREMIER-09  
Matte Anthracite - Grey



RABID22-01  
Matte Black - Red



RABID22-03  
Matte Black - White

**NIKE - Rabid 22**

Stay clear and focused at every angle in the Nike Rabid 22 lead glasses. Added rubber nose bridge and temples prevent slippage and fogging for optimum performance during procedures.

- FRAME SIZE:** Universal
- WEIGHT:** 68 G
- PRESCRIPTION:** Plano, Single Vision, Most Bi-Focal & Bi-Focal Progressive
- COLORS:** Matte Black - Red, Matte Black - White
- PROTECTION:** .75mm LE
- INCLUDES:** Anti-fog spray, safety strap add-on, protective case

Lens Width: 60.5mm    Bridge Width: 16mm    Temple Length: 135mm    Lens Height: 38mm



**NIKE - Wave**

The Nike Wave lead glasses feature a slim profile. Textured rubber on temple tips adds stability and grip.

- FRAME SIZE:** Universal
- WEIGHT:** 57G
- PRESCRIPTION:** Plano, Single Vision, Most Bi-Focal & Bi-Focal Progressive
- COLORS:** Ironstone - Grey
- PROTECTION:** .75mm LE
- INCLUDES:** Anti-fog spray, safety strap add-on, protective case

Lens Width: 53mm    Bridge Width: 18mm    Temple Length: 140mm    Lens Height: 42.6mm



WAVE-01  
Ironstone - Grey



RADIATION PROTECTION GLASSES

GUCCI





GG0613-002  
Havana Gold



GG0613-003  
Pink Transparent

### GG0613

Frame Size	52mm - 16mm - 140mm
Prescription	Plano, Single Vision, Most Bi-Focal & Bi-Focal Progressive
Colors	Havana Gold, Pink Transparent
Weight	53 G
Protection	.75 mm LE
Includes	Case, Cloth & Anti-Fog Spray

Lens Width: 52mm



Bridge Width: 16mm



Temple Length: 140mm

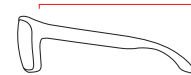

Feminine Gucci radiation protection eyewear combines luxury design heritage with small bridge styling and 0.75mm lead equivalent protection for elegant clinical safety.



**GG1573-001**  
Matte Black

**GG1573-001**

Bold Gucci rectangular radiation protection eyewear features distinctive emblem detailing and signature flag colorway accents with 0.75mm lead equivalent protection for style-conscious professionals.

<b>Frame Size</b>	55mm - 16mm - 145mm
<b>Prescription</b>	Plano, Single Vision, Most Bi-Focal & Bi-Focal Progressive
<b>Colors</b>	Matte Black
<b>Weight</b>	70 G
<b>Protection</b>	.75 mm LE
<b>Includes</b>	Case, Cloth & Anti-Fog Spray

Lens Width: 55mm

Bridge Width: 16mm

Temple Length: 145mm

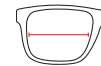

**GG1816-007**

Gracefully curved Gucci radiation protection frames feature the brand's signature attention to detail with small bridge design and 0.75mm lead equivalent lenses.

<b>Frame Size</b>	54mm - 16mm - 145mm
<b>Prescription</b>	Plano, Single Vision, Most Bi-Focal & Bi-Focal Progressive
<b>Colors</b>	Black with Pink Transparent
<b>Weight</b>	69 G
<b>Protection</b>	.75 mm LE
<b>Includes</b>	Case, Cloth & Anti-Fog Spray

Lens Width: 54mm

Bridge Width: 16mm

Temple Length: 145mm



**GG1816-007**  
Black with Pink Transparent



GG1612-001  
Black Crystal

**GG1612-001**

Distinguished Gucci radiation protection glasses showcase iconic flag colorway temples with adjustable nose pads and 0.75mm lead equivalent lenses, merging luxury with essential safety.

Frame Size	54mm - 16mm - 145mm
Prescription	Plano, Single Vision, Most Bi-Focal & Bi-Focal Progressive
Colors	Black Crystal
Weight	TBD
Protection	.75 mm LE
Includes	Case, Cloth & Anti-Fog Spray

Lens Width: 54mm

Bridge Width: 16mm

Temple Length: 145mm



**GG1737-001**

Lightweight rectangular radiation protection glasses featuring 0.75mm lead equivalency and subtle Gucci branding for sophisticated safety in clinical environments.

Frame Size	54mm - 16mm - 145mm
Prescription	Plano, Single Vision, Most Bi-Focal & Bi-Focal Progressive
Colors	Black
Weight	67 G
Protection	.75 mm LE
Includes	Case, Cloth & Anti-Fog Spray



GG1737-001  
Black

Lens Width: 54mm

Bridge Width: 16mm

Temple Length: 145mm

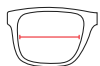



**GG0343-007**  
Multicolor

**GG0343-007**

Sylvie and Web concept glorified by the tri-colored temples with the House tones and new ones. Easy to wear rectangular frame characterized by dark shades in strong contrast with the colored temples. Soft spoken branding with golden Gucci lettering on the temple.

- FRAME SIZE:** 57mm - 18mm - 150mm
- PRESCRIPTION:** Plano, Single Vision, Most Bi-Focal & Bi-Focal Progressive
- COLORS:** Multicolor
- WEIGHT:** 79 G
- PROTECTION:** .75 mm LE
- INCLUDES:** Case, Cloth & Anti-Fog Spray

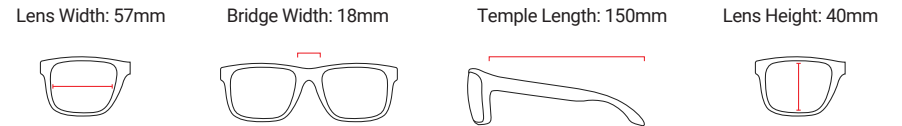

**GG1447**

A best-selling rectangular frame reimaged in a sleek, lightweight acetate. Features refined Gucci logo detailing on the temples and subtle metal accents at the hinges. A timeless design that blends modern minimalism with high-quality craftsmanship.

<b>Frame Size</b>	57mm - 17mm - 145mm Alternative Fit
<b>Prescription</b>	Plano, Single Vision, Most Bi-Focal & Bi-Focal Progressive
<b>Colors</b>	Black, Grey Transparent
<b>Weight</b>	68 G
<b>Protection</b>	.75 mm LE
<b>Includes</b>	Case, Cloth & Anti-Fog Spray



**GG1447-001**  
Black



**GG1447-004**  
Grey Transparent





GG0692-004  
Black

**GG0692-004**

Modern, light and high-quality surgical stainless steel Gucci frame, rectangular masculine shape, and Gucci logo on temples.

- FRAME SIZE:** 57mm - 16mm - 150mm
- PRESCRIPTION:** Plano, Single Vision, Most Bi-Focal & Bi-Focal Progressive
- COLORS:** Black
- WEIGHT:** 83 G
- PROTECTION:** .75 mm LE
- INCLUDES:** Case, Cloth & Anti-Fog Spray

Lens Width: 57mm    Bridge Width: 16mm    Temple Length: 150mm    Lens Height: 38.2mm



**GG0560-005**

Vented radiation protection goggle with neoprene foam on the inside designed to protect against fluid splashing and perspiration. Easy to adjust with elastic head band. Prescription compatible (for most Rx). Lightweight and comfortable. Large lens area for maximum protection.

- FRAME SIZE:** 55mm - 20mm - 145mm
- PRESCRIPTION:** Plano, Single Vision, Most Bi-Focal & Bi-Focal Progressive
- COLORS:** Black/Crystal
- WEIGHT:** 73 G
- PROTECTION:** .75 mm LE
- INCLUDES:** Case, Cloth & Anti-Fog Spray

Lens Width: 55mm    Bridge Width: 20mm    Temple Length: 145mm    Lens Height: 41.6mm



GG0560-005  
Black / Crystal

# GLASSES

## Incredibles

The Incredibles are a stylish wrap around safety frame made of TR-90 high impact resistant plastic. ANSI Z87.1+ approved, lightweight and comfortable. Includes a high quality carrying case. Incredibles glasses are .75mm LE and available from stock in non-prescription.

- FRAME SIZE:** Universal
- WEIGHT:** 75G
- PRESCRIPTION:** Plano, Single Vision (-SV), Bifocal (-BF), Bifocal Progressive (-BF-P)
- COLORS:** Shiny Black, Silver
- PROTECTION:** .75mm LE
- INCLUDES:** Anti-fog spray, safety strap add-on, protective case

Lens Width: 62mm    Bridge Width: 18mm    Temple Length: 145mm    Lens Height: 36mm



860001  
Shiny Black



683260  
Silver



Optional  
Side Protection



830250  
Black



830251  
Red



830252  
Silver



800070  
Blue

## Maxx 30

Prescription compatible (for most Rx), First protective eyewear to receive the American Ophthalmology Associations seal of acceptance. Meets ANSI Z87.1+ standards along with ASTM F803 impact resistance standards. Temple bars and nose bridge have soft rubberized padding for extra comfort, lightweight and comfortable, large lens area for maximum protection Bifocal Progressive Rx frame (requires segment height).

- FRAME SIZE:** Universal
- WEIGHT:** 63G
- PRESCRIPTION:** Plano, Single Vision (-SV), Bifocal (-BF), Bifocal Progressive (-BF-P)
- COLORS:** Black, Red, Silver, Blue
- PROTECTION:** .75mm LE
- INCLUDES:** Anti-fog spray, safety strap add-on, protective case

Lens Width: 53mm    Bridge Width: 17mm    Temple Length: 130mm    Lens Height: 35mm



## Achilles

Vented radiation protection goggle with neoprene foam on the inside designed to protect against fluid splashing and perspiration. Easy to adjust with elastic head band. Prescription compatible (for most Rx). Lightweight and comfortable. Large lens area for maximum protection.

- FRAME SIZE:** Universal
- WEIGHT:** 69G
- PRESCRIPTION:** Plano, Single Vision (-SV), Bifocal (-BF), Bifocal Progressive (-BF-P)
- COLORS:** Blue, Plated Silver, Shiny Black
- PROTECTION:** .75mm LE
- INCLUDES:** Anti-fog spray, safety strap add-on, protective case

Lens Width: 53mm

Bridge Width: 17mm

Frame width: 128mm

Lens Height: 35mm

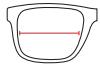

800079  
Shiny Black



800077  
Plated Silver



870002  
Red



870001  
Silver



870003  
Black

## Zone

Rubber nose pads and rubberized temple bars. Wrap around design. Lightweight and comfortable. Large lens area for maximum protection.

- FRAME SIZE:** Universal
- WEIGHT:** 75G
- PRESCRIPTION:** Plano, Single Vision (-SV), Bifocal (-BF), Bifocal Progressive (-BF-P)
- COLORS:** Black, Silver, Red
- PROTECTION:** .75mm LE
- INCLUDES:** Anti-fog spray, safety strap add-on, protective case

Lens Width: 60mm

Bridge Width: 18mm

Temple Length: 135mm

Lens Height: 36mm

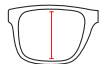

# GLASSES

## Evo

The Evo includes permanent side shields with an adjustable nosepiece. These maximum protection glasses come with .75mm protection and a stylish, sleek look. Side shields for maximum protection. Clear inside plastic frame. Adjustable nose piece. EVO is an RX-friendly frame, and it will hold an SV, BF and BF-P.

- FRAME SIZE:** Universal
- WEIGHT:** 90.4G
- PRESCRIPTION:** Plano
- COLORS:** Matte Black
- PROTECTION:** FRONT: .75mm LE, SIDE: .50mm LE
- INCLUDES:** Anti-fog spray, safety strap add-on, protective case

Lens Width: 55mm    Bridge Width: 17mm    Temple Length: 140mm    Lens Height: 42mm



EVO-01  
Black



ZION-01  
Matte Black



## Zion

The Zion features a large protection area including permanent side shields. These heavy duty glasses are a combination of stylish and protective. Wrap around frame style. Protection on the sides provides a maximum protection of .75mm.

- FRAME SIZE:** Universal
- WEIGHT:** 91.4G
- PRESCRIPTION:** Plano
- COLORS:** Matte Black
- PROTECTION:** FRONT: .75mm LE, SIDE: .75mm LE
- INCLUDES:** Anti-fog spray, safety strap add-on, protective case

Lens Width: 56mm    Bridge Width: 19mm    Temple Length: 135mm    Lens Height: 42mm



## Fitovers MX

The Fitover MX fitover is a versatile, high quality nylon frame. Featuring Flexfit technology, the Fitover MX's temples can be easily adjusted for a secure, comfortable fit. The Fitover MX is ideal for fitting over wide prescription eyewear while still providing a secure and comfortable fit. With the most balanced weight distribution, the Fitover MX is a popular fitover model. Blacked out side shields provide a streamlined look as well as 0.50mm lead equivalent protection.

<b>FRAME SIZE:</b>	Fitover
<b>WEIGHT:</b>	91G
<b>PRESCRIPTION:</b>	Plano
<b>COLORS:</b>	Matte Black
<b>PROTECTION</b>	.75 mm LE
<b>SIDE SHIELDS</b>	0.50mm (standard) Pb Strips
<b>INCLUDES</b>	Anti-fog spray, safety strap add-on, protective case

Lens Width: 69mm



Bridge Width: 17mm



Temple Length: 145mm



FITOVER-MX  
Matte Black



Designed to be worn over Rx frames not exceeding 142 mm wide x 40 mm high (5 5/8" x 1 5/8")



FITOVER-XL  
Matte Black



Designed to be worn over Rx frames not exceeding 142 mm wide x 50 mm high (5 5/8" x 2")

## Fitovers XL

The Fitover XL is a versatile, high quality nylon frame. Featuring Flexfit technology, the Fitover XL lead glasses' temples can be benched (adjusted) easily for a secure, comfortable fit. The Fitover XL is ideal for fitting over standard prescription eyewear with square or rounded lenses. Blacked out side shields provide a streamlined look as well as 0.50mm lead equivalent protection.

<b>FRAME SIZE:</b>	Fitover
<b>WEIGHT:</b>	108G
<b>PRESCRIPTION:</b>	Plano
<b>COLORS:</b>	Matte Black
<b>PROTECTION</b>	.75 mm LE
<b>SIDE SHIELDS</b>	0.50mm (standard) Pb Strips
<b>INCLUDES</b>	Anti-fog spray, safety strap add-on, protective case

Lens Width: 64



Bridge Width: 18mm



Temple Length: 150mm



## GLASSES

### Fitovers Razor

Fits frames not exceeding 132mm width x 38mm height. Wrap around Radiation protection, Hypo-allergenic Crystal Nylon™ Frame. Designed to be worn over small, square, or rectangle prescription eyewear frame shapes.

<b>FRAME SIZE:</b>	Universal
<b>WEIGHT:</b>	82G
<b>PRESCRIPTION:</b>	Plano
<b>COLORS:</b>	Matte Black, Gun Metal, Olive-Charcoal
<b>PROTECTION</b>	.75 mm LE
<b>INCLUDES</b>	Anti-fog spray, safety strap add-on, protective case

Fits over Rx glasses  
not exceeding width:  
**132mm**



Fits over Rx glasses  
not exceeding height:  
**38mm**



800230  
Matte Black



800240  
Gun Metal



800235  
Olive-Charcoal



832001  
Tortoise



832000  
Black

### Fitovers Ecofit

Wrap around Radiation protection with .35mm LE side shield protection. The Hypo-allergenic Crystal Nylon™ Frame is designed to be worn over prescription eyewear

<b>FRAME SIZE:</b>	Universal
<b>WEIGHT:</b>	90 G
<b>PRESCRIPTION:</b>	Plano
<b>COLORS:</b>	Black, Tortoise
<b>PROTECTION</b>	.75mm LE
<b>INCLUDES:</b>	Anti-fog spray, safety strap add-on, protective case

Fits over Rx glasses  
not exceeding width:  
**153mm**



Fits over Rx glasses  
not exceeding height:  
**41mm**



### Fitovers Lotus

Fits frames not exceeding 141mm width x 40mm height. Wrap around Radiation protection. Hypo-allergenic Crystal Nylon™ Frame. Designed to be worn over medium, oval, or round prescription eyewear frame shapes.

- FRAME SIZE:** Universal
- WEIGHT:** 84G
- PRESCRIPTION:** Plano
- COLORS:** Matte Black, Smoke Marble, Claret Stripe
- PROTECTION:** .75mm LE
- INCLUDES:** Anti-fog spray, safety strap add-on, protective case



800304  
Matte Black



800306  
Smoke Marble



800307  
Claret Stripe



683213  
Tortoise Shell

### Premium Wraps

The Premium Wraps feature a large prescription compatible front lens area with maximum radiation protection and side lens for peripheral vision. The frames include spring hinges, formable side temple bars and a fully adjustable nose piece.

- FRAME SIZE:** Universal
- WEIGHT:** 97.3G
- PRESCRIPTION:** Plano
- COLORS:** Tortoise Shell
- PROTECTION:** FRONT: .75mm LE, SIDE: .75mm LE
- INCLUDES:** Anti-fog spray, safety strap add-on, protective case

Lens Width: 57mm

Bridge Width: 19mm

Temple width: 140mm

Lens Height: 59mm

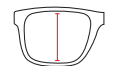
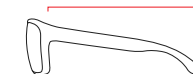
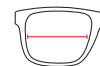

# GLASSES

## Cyber Flex

High Quality Safety Glasses. Adjustable temple bar. Large viewing area. Side protection, 0.50mm with an oversized protective lens area.

- FRAME SIZE:** Universal
- WEIGHT:** 95.4G
- PRESCRIPTION:** Single Vision, Plano
- COLORS:** Clear-/ Navy Blue
- PROTECTION:** .75mm LE
- INCLUDES:** Anti-fog spray, safety strap add-on, protective case

Lens Width: 59mm    Bridge Width: 19mm    Temple Length: 135-150mm    Lens Height: 40mm



683206-S  
Clear / Navy Blue

## Flip Top

“Flip Top” radiation goggles are an all new product, designed to reduce scatter radiation by as much as 70% (actual reduction is dependent upon imaging technique used) Lightweight, Large protective area: 50mm x 160mm. Flips open when not needed. Adjustable nose bridge. Can be used as a stand alone radiation reduction goggle or fits easily over your existing glasses.

- FRAME SIZE:** Universal
- WEIGHT:** 38G
- PRESCRIPTION:** Plano
- COLORS:** Black
- PROTECTION:** .07mm LE
- INCLUDES:** Anti-fog spray, safety strap add-on, protective case

Lens Width: N/A    Total Width: 160mm    Temple Length: N/A    Lens Height: 50mm



800280  
Black

# INFAB Radiation Protection Surgical Gloves

## Thinnest Lead-Free Gloves for Maximum Safety

Our Radiation Protection Surgical Gloves set the benchmark in combining safety and dexterity. Our lead-free, powder-free, and latex-free gloves are the thinnest available, offering outstanding radiation protection while maintaining the tactile sensitivity essential for surgical precision.

- Lead-free
- Latex-free
- Powder-free
- Ultra-thin design
- ASTM tested
- Multiple sizes available

<b>Thickness</b>	0.007" / 0.18 mm
<b>Color</b>	Black
<b>Material</b>	Tungsten
<b>Sizes</b>	6.5, 7.0, 7.5, 8.0, 8.5, 9.0
<b>Compliance</b>	Tested to ASTM F2547-06

<b>Size</b>	<b>Model</b>
6.5	797165
7	797170
7.5	797175
8	797180
8.5	797185
9	797190

Attenuation Properties		
Source Potential	Aluminum Half-Value Level	Measured Attenuation
60 kVp	2.9	56.5%
80 kVp	4.0	47.1%
100 kVp	5.1	41.6%
120 kVp	6.2	37.7%



# Neoprene Gloves

## Optimal Protection with Tactile Sensitivity

Designed to reduce the amount of scattered radiation exposure to the hands from the primary X-ray beam during radiological procedures. These gloves are Latex-Free, Lead-Free, and of course radiation protected.

- Lead-free
- Latex-free
- Powder-free
- High sensitivity
- 30% reduction of direct beam radiation transmitted at 100 kVp
- Packed in sterile pouch
- Shipped from stock

<b>Color</b>	White
<b>Sizes</b>	6.5, 7.0, 7.5, 8.0, 8.5, 9.0

<b>Size</b>	<b>Model</b>
6.5	683310
7	683315
7.5	683320
8	683325
8.5	683330
9	683335

Attenuation Properties		
Source Potential	Cuff Attenuation	Finger Attenuation
60 kVp	38%	49%
80 kVp	30%	40%
100 kVp	24%	33%
120 kVp	19%	27%



# Revolution Radiation Gloves

## Superior Safety and Enhanced Touch Precision

INFAB's Exclusive Revolution Radiation Protection gloves are designed to be the most comfortable, flexible, lightweight and protective gloves. Revolution Radiation Protection Gloves come with tactile grip finger tips. The tactile grip helps with keeping a strong grasp on instruments during a long procedure.

- Latex-free
- Powder-free
- Tactile grip
- Tactile sensitivity
- Sterile
- Maximum tactile sensitivity
- Anatomical fit

<b>Color</b>	Black
<b>Sizes</b>	6.5, 7.0, 7.5, 8.5

Size	Model Light	Model Medium	Model Heavy
6.5			775065
7		735070	
7.5			
8			
8.5	700185		775085
9	700190		

Attenuation Properties			
Source Potential	Model Light	Model Medium	Model Heavy
60 kVp	40%	68%	75%
80 kVp	35%	80%	69%
100 kVp	30%	54%	63%



# Revolution Maxi-Flex Gloves

## Supreme Comfort and Dexterity

The perfect way to ensure your hands and lower forearms are fully protected by the most flexible, comfortable radiation protection gloves on the market. Comfortable fit with maximum dexterity. Soft removable, washable and replaceable inner liners reduce odors and allow for washing. Durable outer covers can be replaced. Revolution Maxi-Flex 5 Finger Lead-Free Gloves come exclusively in our Revolution fabric, the softest and most comfortable material available for radiation protection.

<b>Models</b>	683300- Gloves (Pair) 683306- Replacement Liners 683307- Replacement Covers
<b>Size</b>	15"
<b>Color</b>	Revolution Colors
<b>Protection</b>	.50mm LE

- Revolution Fabric in solid colors
- Tough, durable outer coverings
- Soft, flexible and comfortable
- Removable, washable and replaceable Brrr° Cooling Interior Fabric
- Replaceable outer covers



712- Ducks Green



707- Yellow



715- Orange



719- Coral



704- Pink



701- Red



713- Tide Red



702- Fuchsia



710- Purple



705- Navy



718- Royal Blue



708- Sky Blue



717- Light Blue Serenity



714- Jewelry Box Blue



706- Teal



709- Grey



700- Black



711- White



## Split Palm Mittens

Outstanding manual dexterity. Slotted palm allowing the fingers to be extended from the mitten. Complete hand and lower arm protection.

<b>SIZES:</b>	15"
<b>COLORS:</b>	Revolution Colors
<b>PROTECTION:</b>	.50mm LE
<b>OPTIONS:</b>	683700 - Open Palm Mittens (Pair)

## Split Palm Mittens with Flap

Special flap to close the opening in the mitten when finger extension is not desired. Outstanding manual dexterity. Slotted palm allowing the fingers to be extended from the mitten. Complete hand and lower arm protection.

<b>SIZES:</b>	15"
<b>COLORS:</b>	Revolution Colors
<b>PROTECTION:</b>	.50mm LE
<b>OPTIONS:</b>	683710 - Open Palm Mittens (Pair)





684000 Hand Shields

### Hand Shields - 684000

Durable, comfortable and fully adjustable shields. Full upper hand protection with total mobility of the hand and fingers. Finger retainers are constructed of durable 1" polypropylene webbing. Hook and loop closure at wrist offers plenty of adjustment.

**SIZE:** One Size Fits All

**COLORS:** Blue

**PROTECTION:** .50mm LE

- Durable, comfortable and fully adjustable
- Total mobility of the hand and fingers
- Hook and loop closure

### Maxi-Flex Mittens

The perfect way to ensure your hands and lower forearms are fully protected by the most flexible, comfortable radiation protection mitten on the market.

**SIZE:** 15"

**COLORS:** Revolution Colors

**PROTECTION:** .50mm LE

- OPTIONS:**
- 683303- MAXI-FLEX Mittens (Pair)
  - 683308- MAXI-FLEX Mittens Replacement Liners
  - 683309- MAXI-FLEX Mittens Outer Cover

- Soft, flexible and comfortable
- Removable, washable and replaceable  
Brr° Cooling Interior Fabric inner liners
- Replaceable outer covers
- Removable, washable and replaceable inner liners



# Barriers

INFAB high-quality radiation protection barriers are purpose-built to handle the daily rigors of hospital use. These smooth-rolling and easy-maneuvering barriers offer the highest levels of radiation protection in the industry.

## WINDOW

Your choice of 2.0mm LE lead glass, completely encased with acrylic panels to help prevent damage and breakage, or .50mm LE acrylic.

## CASTERS

Hospital-grade swivel locking casters for easy mobility and positive and secure placement.

## COLORS

Standard white, black or grey.  
Custom options available. Upcharge applies.

## CUSTOMIZATION

- Color: Frames can be custom powder coated in any pantone color (upcharge applies)
- Size: INFAB can produce barriers to your specification
- Logo: Add your logo to any barrier
- Stainless Steel: Optional stainless steel frame

## FRAME

Powder coated steel frame. Precision TIG welded for years of trouble-free service completely enclosing the leaded glass panel for increased durability and safety.

## PROTECTION

- 2.0mm LE lead glass or .50mm LE acrylic window
- 1.5mm LE base panel
- 2 0.75mm LE Curtains (1.5mm LE.)



# STANDARD BARRIERS

Available in a variety of heights, widths, and window configurations, INFAB barriers are fully customizable, to any specifications. Custom colors, logos and 100% stainless steel options are available. Full head-to-toe protection with our exclusive base curtain included on every barrier. Your choice of 2.0mm LE lead glass or .50mm LE acrylic window. All bases are 1.50mm LE.



**683492**

## Large Window Mobile Barrier

**SIZE:** 80¼" H x 40½" W X 25" D  
**WINDOW:** 72" H x 36" W  
**GLASS:** Lead or Acrylic (-AC)  
**SHIPPING** Crate: 30" x 78" x 48"  
 480lbs / 217.72 kg

**683476**

## X-Tall Mobile Barrier

**SIZE:** 78¼" H x 40½" W X 25" D  
**WINDOW:** 60" H x 36" W  
**GLASS:** Lead or Acrylic (-AC)  
**SHIPPING:** Crate: 30" x 78" x 48"  
 450lbs / 204.12 kg

**683488**

## X-Wide Mobile Barrier

**SIZE:** 74½" H x 76½" W X 25" D  
**WINDOW:** 36" H x 72" W  
**GLASS:** Lead or Acrylic (-AC)  
**SHIPPING:** Crate: 32" x 85" x 85"  
 600lbs / 272.16 kg

**683473**

## Mid Tall Mobile Barrier

**SIZE:** 74½" H x 34½" W X 25" D  
**WINDOW:** 60" H x 30" W  
**GLASS:** Lead or Acrylic (-AC)  
**SHIPPING:** Crate: 73" x 30" x 43"  
 380lbs/172.36kg

# BARRIER FEATURES

- All INFAB Barriers include four hospital grade casters, 2 with locking brakes.
- Fully enclosed glass with our exclusive concussion panels to protect the lead glass.
- Easy-clean Sintra plastic base and high quality powder coated steel frames.



**683482**

**Wide Mobile Barrier**

**SIZE:** 72" H x 52½" W X 25" D  
**WINDOW:** 36" H x 48" W  
**GLASS:** Lead or Acrylic (-AC)  
**SHIPPING:** Crate: 30" x 72" x 60"  
 480 lbs / 217.72 kg

**683465**

**Small Window Mobile Barrier**

**SIZE:** 72¼" H x 52½" W X 25" D  
**WINDOW:** 12" H x 12" W  
**GLASS:** Lead or Acrylic (-AC)  
**SHIPPING:** Crate: 30" x 72" x 60"  
 380 lbs / 217.72 kg

**683468**

**Medium Window Mobile Barrier**

**SIZE:** 74" H x 52½" W X 25" D  
**WINDOW:** 12" H x 24" W  
**GLASS:** Lead or Acrylic (-AC)  
**SHIPPING:** Crate: 73" x 30" x 57"  
 410 lbs / 185.97 kg

**683460**

**Standard Mobile Barrier**

**SIZE:** 72" H x 34½" W X 25" D  
**WINDOW:** 24" H x 30" W  
**GLASS:** Lead or Acrylic (-AC)  
**SHIPPING:** Crate: 30" x 72" x 42"  
 335 lbs / 151.95 kg

**683484**

**Regular Mobile Barrier**

**SIZE:** 64½" H x 40½" W X 25" D  
**WINDOW:** 24" H x 36" W  
**GLASS:** Lead or Acrylic (-AC)  
**SHIPPING:** Crate: 30" x 65" x 48"  
 430 lbs / 195.04 kg

**683458**

**"Shorty" Mobile Barrier**

**SIZE:** 45" H x 34½" W X 25" D  
**WINDOW:** 24" H x 30" W  
**GLASS:** Lead or Acrylic (-AC)  
**SHIPPING:** Crate: 45" x 30" x 42"  
 220 lbs / 99.79 kg



**683461 Tilted Mobile Barrier**

- WINDOW:** 2.0mm LE Lead Glass or .50mm LE Acrylic
- WINDOW SIZE:** 24" H x 30" W
- OVERALL SIZE:** 70" H x 34 1/4" W X 25" D
- COLORS:** Standard white, grey or black. Custom options available.
- FRAME:** Metal, Stainless Steel (Upgrade)
- SHIPPING:** Crate: 73" x 30" x 43", 355 lbs / 161.03 kg
- Powder coated steel frame
- Acrylic impact panels, enclosed in a precision TIG welded frame for years of trouble-free service, completely enclosing the leaded glass panel for increased durability and safety
- 2 high-quality hospital grade locking casters
- 1.50mm LE opaque base covered in "Sintra" plastic for easy cleaning and durability
- Modular parts can be easily replaced, including the glass if needed.
- Ergonomical viewing area
- Shipping worldwide by ground, air or sea freight

Tilted design for better view





### 076993 Technician Protection Mobile Screen

The Technician Protection Mobile Screen can be easily raised and lowered by hand and stays in position thanks to the perfectly counter-balanced internal springs. The high quality steel construction and stainless springs provide a lifetime of trouble-free use.

**SIZE RAISED:** 73" H x 31" W x 20 1/2" D

**SIZE LOWERED:** 44" H x 31" W x 20 1/2" D

**WINDOW SIZE:** 37.4" H x 27" W

**COLORS:** Standard white, grey or black. Custom options available.

**FRAME** Metal, Stainless Steel (Upgrade)

**SHIPPING:** Crate: 31" x 49" x 41", 210 lbs/95.25kg

- Retractable Window
- Multiple heights
- Perfectly counter balanced
- Easily raised and lowered
- .50mm LE base
- .50mm LE lead acrylic window
- 2 high-quality hospital grade locking casters
- Complete with bar to hold controls





**REV-MHAS**    **Revolution Mobile Hanging Acrylic Shield**

Fully adjustable mobile shield that can be altered to user's preference. This product provides the benefits of an overhead suspension barrier with the mobility to fit into exam rooms of any size. The acrylic barrier can be raised, lowered, and rotated 360° in both vertical and horizontal planes to fit snug against the torso of the patient.

**KEY FEATURES:**

- Mobile unit with superior stability.
- Gives user full control of shield placement.
- Pivot ball allows for 360° motion.
- Durable 0.50mm acrylic shield.
- Small footprint, does not interfere with physician's position at the table.

**DIMENSIONS:**    79" H x 37" W x 25" D

**WINDOW SIZE:**    24" H x 30" W

**PROTECTION:**    Lead acrylic window .50mm LE

**COLORS:**    Standard off-white powder coated.  
Other colors available.

**FRAME**    Powder Coated Steel

**WHEELS:**    4 swivel hospital grade casters (2 with brakes)



Full 360° Pivot ball for precise positioning



Front profile



**REV-PMC**    **Revolution Mobile Curtain**

A unique new design for operating physicians that allows unparalleled protection for close-to-table studies. Sturdy, yet thoughtfully engineered with a small footprint so it can easily be positioned exactly where you want it for maximum scatter radiation protection.

- SIZE:** Adjustable height 43½" - 66"  
Base: 34" W x 25" D
- CURTAIN:** 38"H x 30"W .50mm LE lead curtain with grey Revolution fabric
- FRAME COLORS:** Standard white, grey or black. Custom options available.
- CURTAIN COLORS:** Standard Revolution grey. Custom options available.
- FRAME:** Powder Coated Steel, Stainless Steel (Upgrade)
- SHIPPING:** Box: 13" x 42" x 9", 45 lbs / 20.41 kg  
Box: 26" x 30" x 8", 30 lbs / 13.60 kg

- Special 4 caster T-bar base design to stabilize the unit
- Smooth easy maneuvering
- Special spring mechanism allows for easy raising, lowering, and
- .50mm LE double protective curtain
- 2 high-quality hospital grade locking casters

**Spring mechanism makes it easy to raise and lower and stay in place.**



**REV-SPMC**

**Revolution Solid Panel Mobile Curtain**

- SIZE:** 56" H x 30" W
- CURTAIN:** 30" x 30"
- PROTECTION:** REV-SPMC10 1.0mm LE  
REV-SPMC50 .50mm LE
- FRAME COLORS:** Standard white, grey or black. Custom options available.
- CURTAIN COLORS:** Standard Revolution grey. Custom options available.
- FRAME:** Powder Coated Steel, Stainless Steel (Upgrade)
- SHIPPING:** Box: 21" x 21" x 10", 18 lbs / 8.17 kg  
Box: 16" x 33" x 7", 28 lbs / 12.7 kg

- Heavy-duty hospital-grade purpose-built unit.
- Adjustable height between 37" and 56"
- 30" wide by 30" tall lead vinyl curtain
- 2 high-quality hospital grade locking casters
- Smooth and easy maneuvering



Adjustable height locking system from 37" to 56"





**REV-MC** Economy Mobile Curtain

- SIZE:** 66" H x 28" W
- CURTAIN:** 30" x 30" .50mm LE curtain with grey Revolution fabric
- FRAME COLORS:** Standard white, grey or black. Custom options available.
- CURTAIN COLORS:** Standard Revolution grey. Custom options available.
- FRAME:** Powder Coated Steel, Stainless Steel (Upgrade)
- SHIPPING:** Box: 24" x 30" x 12", 20 lbs / 9.07 kg  
Box: 6" x 6" x 6", 27 lbs / 12.25 kg

- Raise and lower shield
- Smooth easy maneuvering
- .50mm LE double protective curtain
- 2 high-quality hospital grade locking casters



Adjustable height locking system from 16" to 66"



REV-LOCKER-20

## Revolution Mobile Apron Lockers

Features digital passcode locks with keypad

Set up to 3 administrative and user pass

Battery operated lock with backup battery and emergency power supply



Passcode Lock with Keypad



**REV-LOCKER-5**

**Revolution 5 Hanger Mobile Apron Locker**

**ASSEMBLED SIZE:** 65" H x 16" W x 26.5" D

**COLORS:** White, Grey, or Black  
Custom colors available.  
Ships in standard white unless specified.

**SHIPPING:** Crate: 29" x 20" x 70", 170 lbs / 77.11 kg

Includes 5 hangers  
Secure up to 5 aprons



**REV-LOCKER-10**

**Revolution 10 Hanger Mobile Apron Locker**

**ASSEMBLED SIZE:** 65" H x 32" W X 26.5" D

**COLORS:** White, Grey, or Black  
Custom colors available.  
Ships in standard white unless specified.

**SHIPPING:** Crate: 29" x 36" x 70", 205 lbs / 93 kg

Includes 10 hangers  
Secure up to 10 aprons



**REV-LOCKER-20**

**Revolution 20 Hanger Mobile Apron Locker**

**ASSEMBLED SIZE:** 65" H x 48" W X 26.5" D

**COLORS:** White, Grey, or Black  
Custom colors available.  
Ships in standard white unless specified.

**SHIPPING:** Pallet: 29" x 52" x 70", 230 lbs / 148.33 kg

Includes 20 hangers  
Secure up to 20 aprons

# Apron Racks

INFAB Apron Racks are purpose-built pieces of hospital equipment, designed to last as long as the facility they are being used in.

## OPTIONS

- Mobile
- Wall-Mounted
- Single Apron
- Multi-Apron
- Deluxe
- Economy
- Custom Colors

## HOSPITAL GRADE MATERIALS

- Cold-rolled metal or optional stainless steel frames
- Hospital grade casters, two with locking brakes, for easy mobility and positive placement when parked.

## THOUGHTFUL DESIGN

- Easy to use
- Space-efficient
- Plentiful storage
- Easy on/off apron convenience



**REV-MRK-10****Revolution 10 Arm Mobile Apron Rack**

**ASSEMBLED SIZE:** 59<sup>3</sup>/<sub>4</sub>" H x 43" W X 31" D

**COLORS:** White, Custom Options

**SHIPPING:** Box 1: 16" x 58" x 9", 52 lbs / 23.59 kg  
Box 2: 34" x 45" x 14", 58 lbs / 26.31 kg

- Holds up to 10 vest and skirt aprons
- Vest and skirts hang on a single arm
- Handy storage area on base
- Heavy duty hangers that swivel on a sealed ball bearing for years of trouble-free use
- New circular tube design with sleek look



**683435**

**10 Hanger Mobile Apron Valet**

**ASSEMBLED SIZE:** 58" H x 26½" W X 25" D

**COLORS:** White/Chrome, Custom Options

**SHIPPING:** Box 1: 55" x 7" x 7", 25 lbs / 11.34 kg  
Box 2: 16" x 32" x 14", 34 lbs / 15.42 kg

- Space saving; providing major storage while taking up minimum space.
- Steel construction with baked enamel finish.
- 2 high-quality hospital grade locking casters
- 10 Deluxe Custom Apron Hangers (683450) included



**683438**

**20 Hanger Mobile Apron Valet**

**ASSEMBLED SIZE:** 58" H x 48½" W X 25" D

**COLORS:** White/Chrome, Custom Options

**SHIPPING:** Box 1: 55" x 7" x 7", 32 lbs / 14.51 kg  
Box 2: 16" x 32" x 14", 43 lbs / 19.50 kg

- Space saving; providing major storage while taking up minimum space.
- Steel construction with baked enamel finish.
- 2 high-quality hospital grade locking casters
- 20 Deluxe Custom Apron Hangers included
- Optional: full circle loop hangers (-H)



**683419**

**Mini Mobile Apron Rack with Hangers**

**ASSEMBLED SIZE:** 78" H x 27" W X 25" D

**COLORS:** White, Custom Options

**SHIPPING:** Box: 29" x 49" x 8", 59 lbs / 26.76 kg

- Six apron hangers included
- Heavy gauge cold rolled steel
- Powder coated
- Attractive, durable, long lasting finish
- 2 high-quality hospital grade locking casters
- Holds up to six protection aprons, a pair of lead gloves and two pairs of radiation protection glasses



**683407**

**Deluxe Mobile Apron Rack**

**ASSEMBLED SIZE:** 53" H x 39" W X 26" D

**COLORS:** White, Custom Options

**SHIPPING:** Box 1: 16" x 32" x 14", 25 lbs / 11.34 kg  
 Box 2: 40" x 29" x 12", 55 lbs / 24.95 kg  
 Box 3: 58" x 17" x 9", 52 lbs / 23.59 kg

- Super heavy-duty
- 2 high-quality hospital grade locking casters
- Stores up to ten protection aprons
- Optional vest and skirt adapter (Part Number 683000)
- Holds up to 200 lbs. of aprons



**683426**

**5 Arm Budget Saver Mobile Apron Rack**

**ASSEMBLED SIZE:** 58" H x 26" W X 30" D

**COLORS:** White, Custom Options

**SHIPPING:** Box 1: 51" x 7" x 7", 31 lbs / 14.06 kg  
 Box 2: 16" x 32" x 14", 34 lbs / 15.42 kg  
 Box 3: 16" x 41" x 7", 21lbs / 9.53 kg  
 Box 4: 26" x 21" x 2", 12 lbs / 5.44 kg

- Economically priced
- Heavy gauge steel
- Powder coated
- 2 high-quality hospital grade locking casters
- Stores up to 5 protection aprons
- Convenient additional storage on base
- Optional vest and skirt adapter (Part Number 683000)



**683427**

**10 Arm Budget Saver Mobile Apron Rack**

**ASSEMBLED SIZE:** 58" H x 44½" W x 30" D

**COLORS:** White, Custom Options

**SHIPPING:** Box 1: 51" x 7" x 7", 36 lbs / 16.33 kg  
 Box 2: 16" x 32" x 13", 34 lbs / 15.42 kg  
 Box 3: 58" x 16" x 9", 40 lbs / 18.14 kg  
 Box 4: 22" x 44" x 2", 21 lbs / 9.53 kg

- Economically priced
- Heavy gauge steel
- Powder coated
- 2 high-quality hospital grade locking casters
- Stores up to 10 protection aprons
- Convenient additional storage on base
- Optional vest and skirt adapter (Part Number 683000)

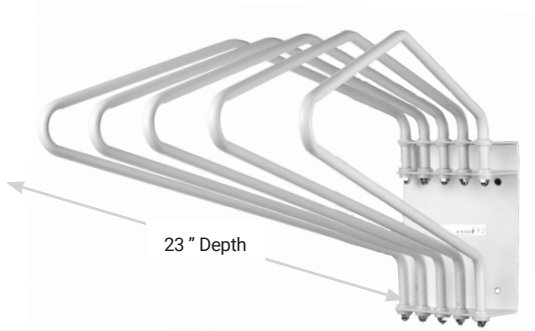

**683101**

5 Arm Left Folding Apron Rack

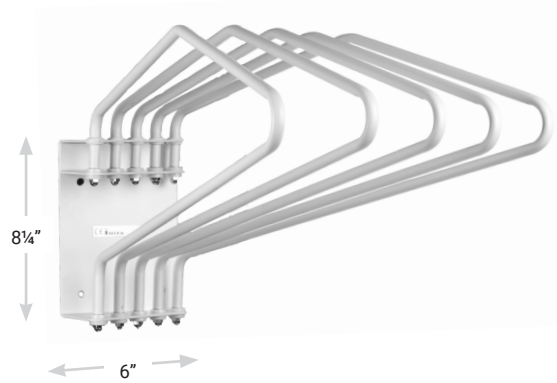

**683100**

5 Arm Right folding Apron Rack

**Wall-Mounted 5 Arm Apron Rack**

**ASSEMBLED SIZE:** 8 1/4 H x 6" W X 23" D

**COLORS:** White, Custom Options

- Stores up to 5 aprons
- Swings out easily for immediate access to aprons
- Heavy duty
- Power coated steel mounting bracket and storage arms
- Arms with nylon bushings
- Racks fold flush to wall
- Can be mounted side by side
- Optional vest and skirt adapter (Part Number 683000)



**683000**  
Vest and Skirt Rack Adapter

- Skirt rack adapter easily mounts to rack with included tool. Skirt hanging adapter provides convenient storage for vest & skirt aprons.

**SHIPPING**

<b>683100</b> 5 Arm Folding Right Hand Folding	Box 1: 10 lbs (12" x 30" x 6")
<b>683101</b> 5 Arm Folding Left Hand Folding	Box 1: 10 lbs (12" x 30" x 6")

**683415** Wall-Mounted Wall Tower Rack

**ASSEMBLED SIZE:** 48" H x 13 3/4" W X 27" D (w/racks)

**COLORS:** White, Custom Options

- Includes right and left 5 arm apron racks
- Heavy duty
- Handles toughest hospital environments
- Heavy gauge steel
- Powder coated
- Scratch resistant
- Easy to install
- Hardware provided
- Requires only minimal space
- 13.75" wide x 48" tall

**SHIPPING**

683115 Weak Wall Support

Box 1: 10 lbs (12" x 30" x 6")

683415 Rack/Tower W/ R.H. & L.H. Racks

Box 1: 10 lbs (12" x 30" x 6")



**683415**  
Wall Tower Rack with right and left hand racks

**683115**  
Weak Wall Support

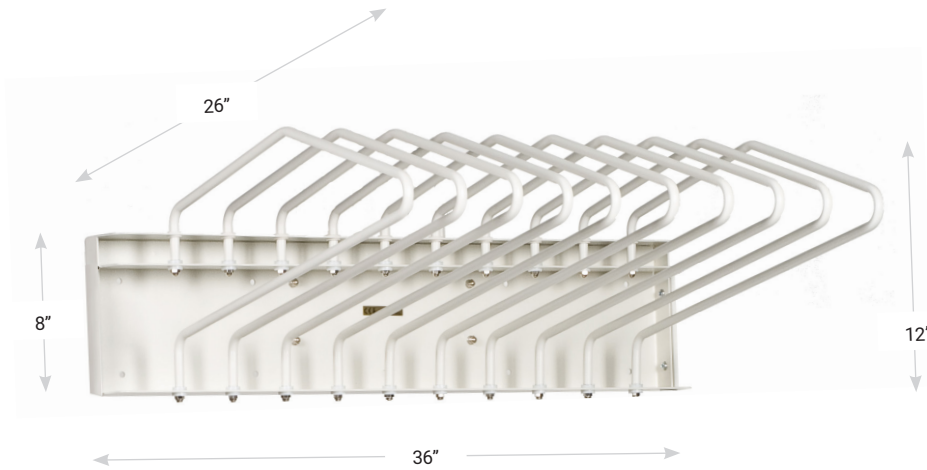

**683429 Wall Mounted Rack**

**ASSEMBLED SIZE:** 12" H x 36" W X 26" D

**COLORS:** White, Custom Options

- Heavy gauge steel
- 200 lbs. capacity
- Powder coated
- Scratch resistant
- Easy to install
- Requires only minimal space
- Stores up to 10 aprons
- Optional vest and skirt adapter (Part Number 683000)

**683429 SHIPPING**

Box 1: 40 lbs (16" x 58" x 9")

**683430 Apron and Glove Combination Rack**

**ASSEMBLED SIZE:** 17" H x 28¾" W (9½" Baseplate)

**COLORS:** White, Custom Options

- Rounded corners to prevent accidental apron tears or skin punctures
- Quick, convenient storage
- Stores 1 apron and 1 pair of lead gloves
- Sturdy & compact
- Mounts quickly and easily
- Heavy gauge steel mounting plate
- Half inch outside diameter tubing
- Electro static powder coated

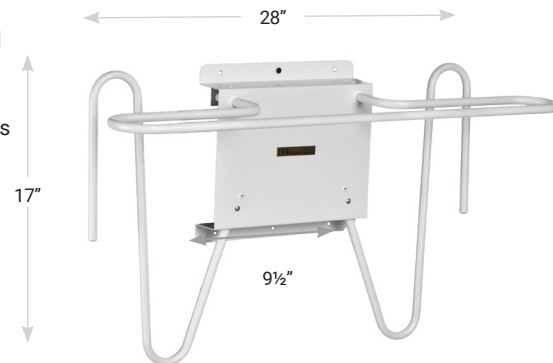

**683430 SHIPPING**

Box 1: 9 lbs. (19" x 30" x 11")

**683420 Apron and Glove Storage Rack**

**ASSEMBLED SIZE:** 25" H x 28" W x 6" D

**COLORS:** White, Custom Options

- Quick, convenient storage
- Sturdy
- Compact
- Mounts quickly and easily
- Heavy gauge steel mounting plate
- Half inch outside diameter tubing
- Electro static powder coated
- Great for dental aprons

**683420 SHIPPING**

Box 1: 15 lbs (26" x 31" x 8")



**683102 Protective Accessories Rack**



**ASSEMBLED SIZE:** 21" H x 18½" x 5" D

**COLORS:** White, Custom Options

- Storage unit for two or more aprons, a pair of glasses and a pair of lead gloves
- Mounts quickly and easily
- 18" wide
- Extends a mere 4.5" from the wall
- Contains no sharp edges
- Perfectly suited to small areas
- Powder coated heavy steel construction

**683102 SHIPPING**

Box 1: 8 lbs (19" x 23" x 8")

**683424 Single Bar Apron Rack**



**ASSEMBLED SIZE:** 6" H x 18 ½" W x 3" D

**COLORS:** White, Custom Options

- Storage unit for one apron
- Mounts quickly and easily
- Contains no sharp edges
- Perfectly suited to small areas
- Powder coated heavy steel construction

**683102 SHIPPING**

Box 1: 3 lbs (24" x 4" x 8")

**683452 Locker Size Hanger**



**SIZE:** 6" H x 14 ½" W

**COLORS:** White, Custom Options

- Securely hold a radiation protection apron
- Constructed from heavy gauge steel tube
- Designed to fit in personal locker
- Powder coated



Optional hook (-H)

**683450 Deluxe Custom Hanger**



**SIZE:** 7½" x 22½"

**COLORS:** Chrome, Custom Options

- Securely hold a radiation protection apron
- Constructed from heavy gauge steel tube
- Chrome plated
- Available in a pack of 5 hangers
- Part Number 683451



Optional hook (-H)

**683412** Two Peg Wall Mounted Rack



**683412** Two Peg Wall Mounted Rack      **683412-LS** Two Peg Wall Mounted Rack with Locking System

**ASSEMBLED SIZE:** 9" H x 15 ¼" W x 7¼" D  
**COLORS:** White, Custom Options  
**SHIPPING:** Box: 11" x 18" x 9", 6 lbs / 2.72 kg

**683410** Six Peg Wall Mounted Rack



**683410** Six Peg Wall Mounted Rack      **683410-LS** Six Peg Wall Mounted Rack with Locking System

**ASSEMBLED SIZE:** 9" H x 34 ½" W x 7 ¼" D  
**COLORS:** White, Custom Options  
**SHIPPING:** Box: 11" x 37" x 9", 16 lbs / 7.26 kg

**683411** Eight Peg Wall Mounted Rack



**683411** Eight Peg Wall Mounted Rack      **683411-LS** Eight Peg Wall Mounted Rack with Locking System

**ASSEMBLED SIZE:** 9" H x 46 ½" W x 7¼" D  
**COLORS:** White, Custom Options  
**SHIPPING:** Box: 13" x 47" x 10", 21 lbs / 9.53 kg

**LS** Locking System

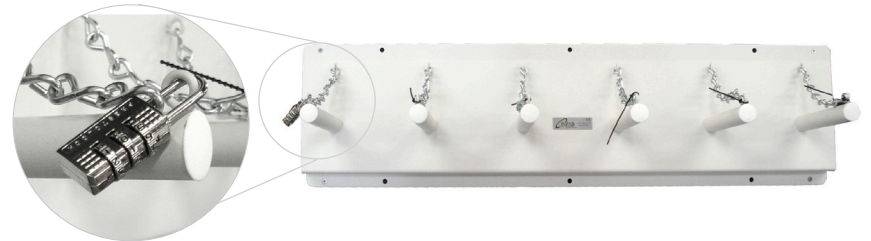

- Available in 2 peg, 6 peg, or 8 peg configurations
- Inexpensive and very effective
- Heavy gauge steel plate
- Electrostatic powder coated
- Tilted storage bars so aprons wont slip off
- Requires minimal space
- Includes lock



## Curtains

INFAB offers customizable radiation protection curtains of superior quality, available in various protection levels, sizes, colors, and fabrics. Our durable curtain tracks are tailored to your specifications for the perfect room fit.

Contact us with your specifications for a customized quote.

### Lead Curtain



Our lead curtains include one grommet hole with a "S" hook every six inches.

**COLORS:** Classic Nylon Colors

**CORE:** Lead, Lead-Free

**PROTECTION:** .25mm LE, .35mm LE, .50mm LE, .75mm LE, 1.0mm LE

**SIZE:** Per square foot

**683650** .25mm LE curtain with grommets (per sq. ft.)

**683655** .35mm LE curtain with grommets (per sq. ft.)

**683660** .50mm LE curtain with grommets (per sq. ft.)

**683670** .75mm LE curtain with grommets (per sq. ft.)

**683675** 1.0mm LE curtain with grommets (per sq. ft.)

**683680** Straight Track for Curtain

Mill finish 6063-T5 extruded aluminum 1-3/4" wide x 2" high, .080 thick.  
Priced per linear foot.

- INCLUDES:**
- 1 Straight Track
  - 2 End Stops
  - 1 Single Carrier for each grommet hole on curtain
- OPTIONS:**
- Clamp Hanger
  - Ceiling Splice
  - Trim Chain

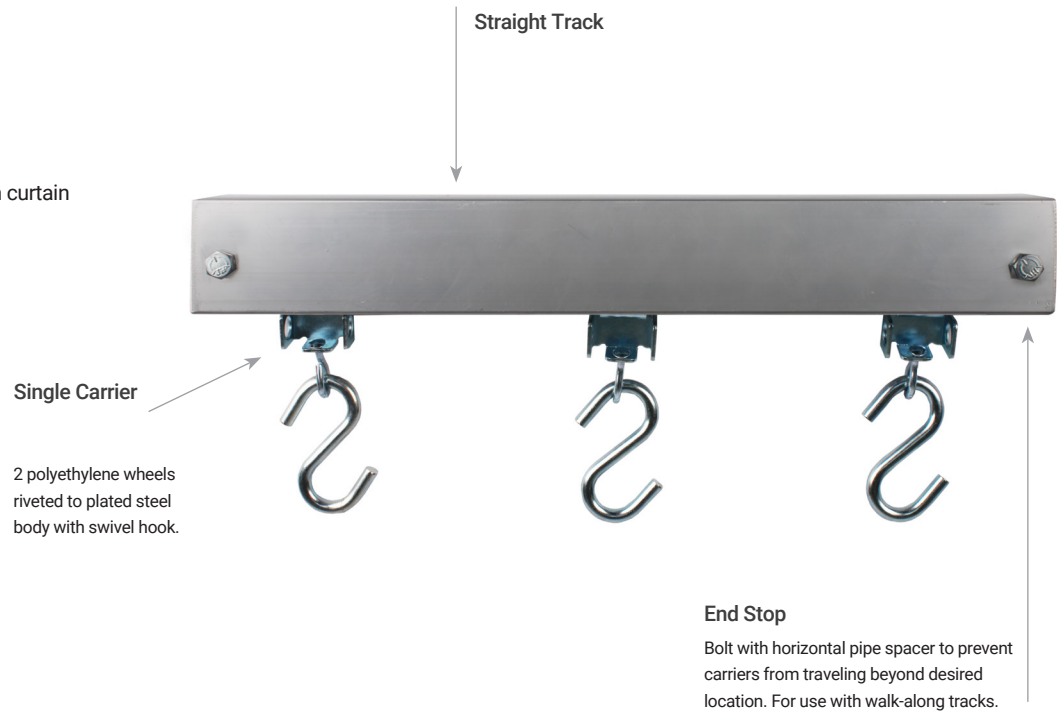

**OPTIONS:**

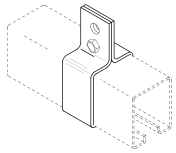

**Clamp Hanger**

Formed steel brackets clamp to track. Adjusts to any position. Suspend track with welded chain or wire rope. 1 pair pictured.

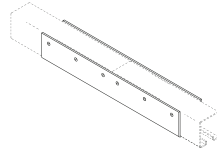

**Ceiling Splice**

To align and lock track sections together on ceiling mounted tracks. 1 pair pictured.

Note: Cannot be used with No. 132 Overlap Master or No. 10 Pivot Device due to interference with the wheels.



**Trim Chain**

3 links No.10 single jack chain added to carriers to provide 3" of curtain height adjustment

# Lead Curtains

These scatter shields are attached to the table to protect both the operator and the patient from harmful radiation.

# Easy Setup & Installation

Easily slides onto most tables with side rails and quickly locks in to place with an adjustable knob.

## 077036 Single Panel Scatter Shield

The below-table protection screen is attached to the table to protect the operator's lower body from radiation. The upper part of the screen (removable) protects against scatter radiation from the patient's body. The lower part protects the operator's lower body against the radiation from the tube source.

### UPPER SCREEN

- .50mm LE with stiff support
- 11" H x 26" W
- Hooks into mobile arm that can be easily removed

### LOWER SCREEN

- .50mm LE made up of 4 strips
- 30" L x 26" W

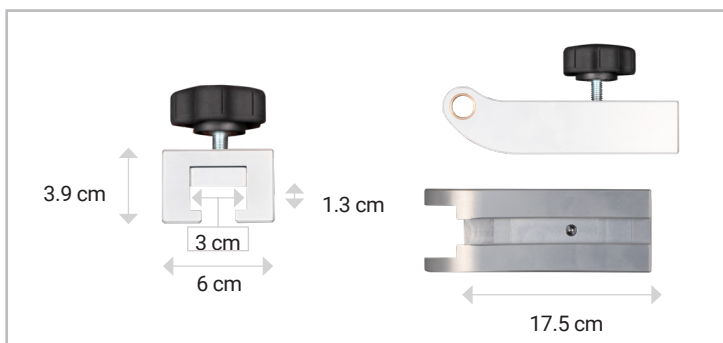

Universal adapter bracket fits almost every table with a side rail

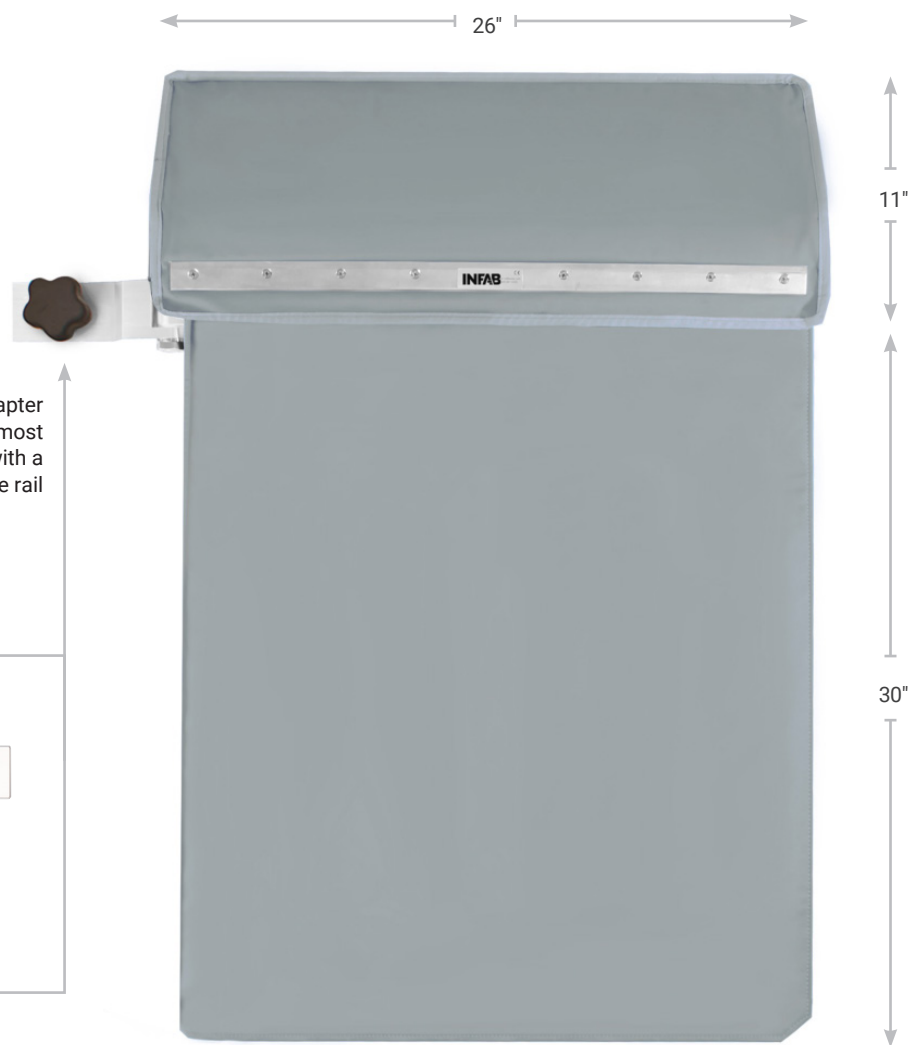

**077035 Multiple Panel Scatter Shield**

The below-table protection screens are attached to the table to protect the operator's lower body from radiation. The upper part of the screen (removable) protects against scatter radiation from the patient's body. The lower part protects the operator's lower body against the radiation from the tube source.

**UPPER SCREEN**

- .50mm LE with stiff support
- 11" H x 26" W
- Hooks into mobile arm that can be easily removed

**LOWER SCREEN**

- .50mm LE made up of 4 strips
- 30" L x 26" W

**ADDITIONAL STRIP (INCLUDED)**

- Applied with addition of intermediate joint
- 30" L x 10" W

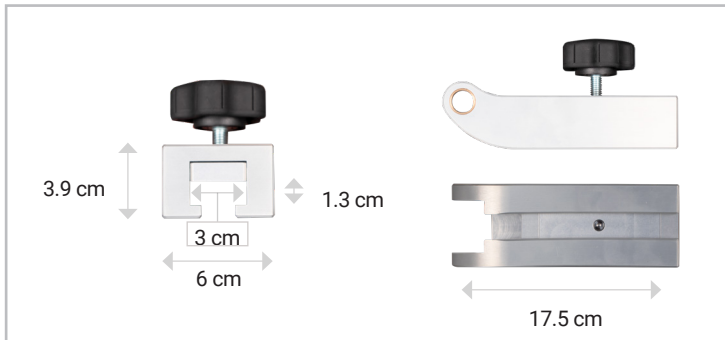
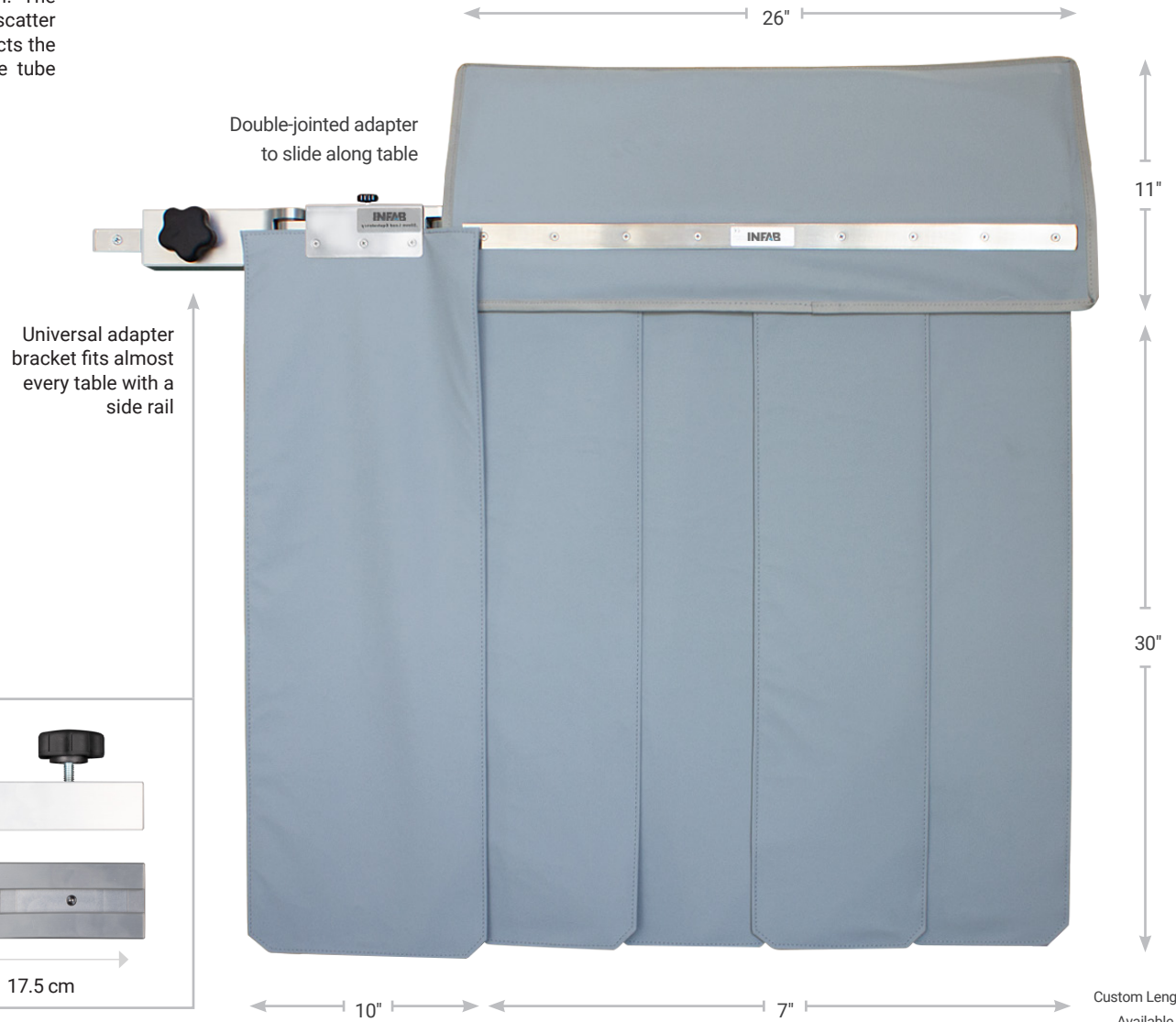

**990007 Saddle Shield Radiation Protection Curtains**

Saddle Shield Radiation Protection Curtains designed to help protect the body from being exposed to radiation.

- .50mm LE
- Significantly reduces scatter radiation
- Overlapping split front panels
- No special hardware or modifications to imaging equipment required
- Available in any of our fabric colors
- Provide exact dimensions and drawing to fit your specific size table

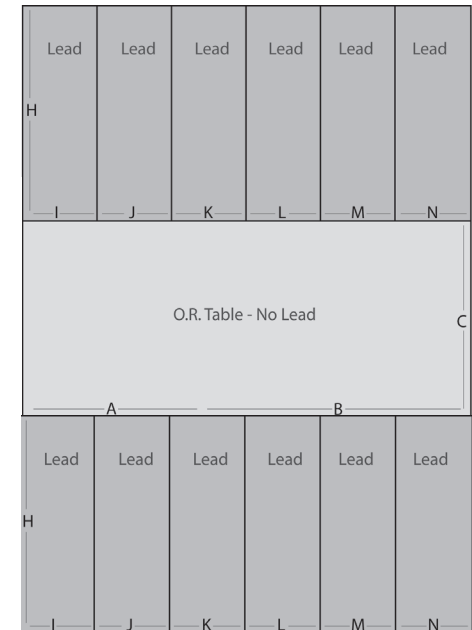
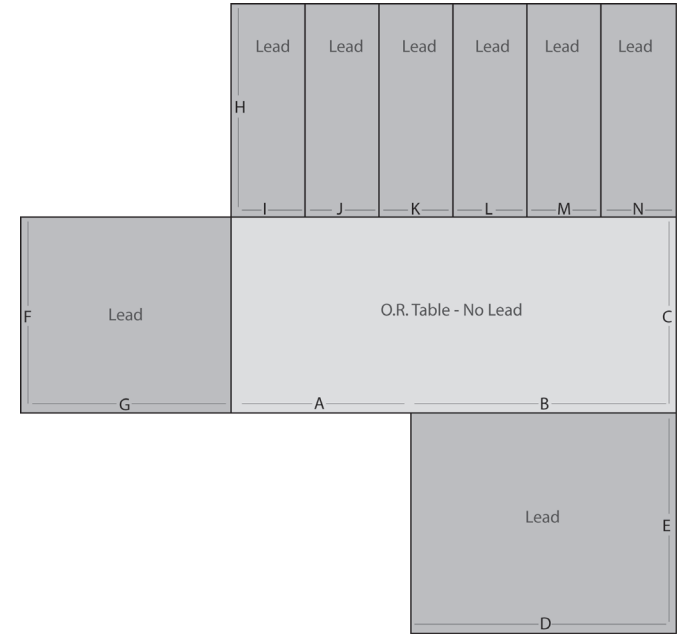

**683400 Patient Protection Set**

- INCLUDES:** Storage rack with 4 aprons (Toddler, Child, Average, Large)
- COLORS:** Classic Nylon Colors
- CORE:** Lead, Lead-Free
- PROTECTION:** .25mm LE, .35mm LE, .50mm LE
- SIZES:** Toddler, Child, Average Adult, Large Adult



683401  
11.5" W x 9" H  
Toddler Apron

683402  
13" W x 13" H  
Child's Apron

683403  
17.5" W x 14" H  
Average Adult Apron

683404  
21" W x 17" H  
Large Adult Apron



**Half Apron**

**HSV**  
Hook and Loop Closure Half Apron

- HSV-S1** 12" x 24" Half apron with hook and loop closure
- HSV-M1** 18" x 24" Half apron with hook and loop closure
- HSV-L1** 24" x 24" Half apron with hook and loop closure



Standard hook and loop closure

**ASB**  
Buckle Closure Half Apron

- ASB-S1** 12" x 24" Half apron with buckle closure
- ASB-M1** 18" x 24" Half apron with buckle closure
- ASB-L1** 24" x 24" Half apron with buckle closure



**PP-ES** Disposable Eye Shields



- Minimum 40% dose reduction
- Box of 50
- Barium sulfate shields are non-latex and 100% disposable

**PP-TS** Disposable Thyroid Shield

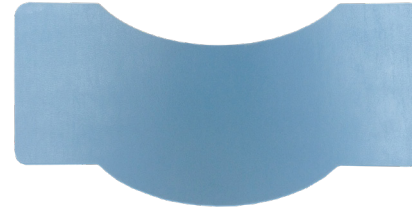

- Minimum 60% dose reduction
- Box of 50
- Barium sulfate shields are non-latex and 100% disposable

**684120** Ovarian Shields



- Set of three (Infant, Youth and Adult)
- Designed especially for ovarian procedures
- 1.0mm LE
- Easy to use and explain to your patient
- Available in our Classic Nylon Colors
- Durable
- Easily wipes clean

**PGS** Gonad Shields



- Set of three or available individually: (Infant, Youth and Adult)
- 3/4" buckle strap
- Easy fastening around the waist
- .50mm LE
- Available in our Classic Nylon Colors

**GND** Triangular Gonad Shields



- Set of three (Infant, Youth and Adult)
- 1/2" inch tie strap
- Easy fastening around the waist
- .50 mm Pb equivalent



**PTD Patient Transfer Device**

- Radiolucent plastic
- 18" or 22" wide models
- Also available with storage rack
- Large hand holds
- One inch wide wrist straps
- Anti-static
- Thin
- Board slides easily from surface to surface
- Tested up to 300 lbs.

**MODELS:** PTD-18, PTD-22

**COLORS:** White

**SHIPPING:** PTD-18  
 Box: 73" x 23" x 1", 11 lbs / 4.99 kg

PTD-22  
 Box: 73" x 23" x 1", 13 lbs / 5.90 kg



**683399 Patient Transfer Rack**

Wall mounted rack for PTD storage

**SIZE** 9" H X 15" <sup>1</sup>/<sub>4</sub> W x 6 <sup>3</sup>/<sub>4</sub>" D

### Table Pads and Covers



**INF-9108**

Canon Aquilion Table Pad w/ Fluid Dam



**INF-9121**

Aquilion Table Pad Cover

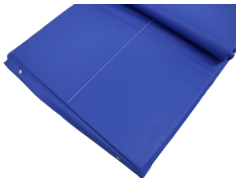

**INF-520**

Premium Heavy Duty Table Pad



**INF-9409**

Canon Interventional Table Pad

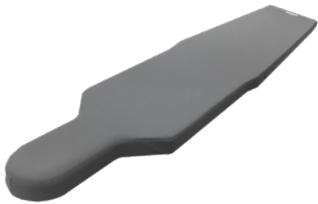

**INF-33535**

Philips AD7 Neuro Table Pad

### Head and Neck Positioning



**INF-112-SCB**

Circular Disk with ScanCoat®



**INF-463**

MRI Comfort Pillow



**INF-9007**

Forehead Strap with Adult Pad



**INF-9008**

Adult Head Rest

## Wedges and Blocks

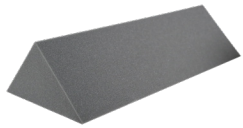

**INF-145**

7" H x 7" W x 21.25" L  
Spinal Wedge - 45°

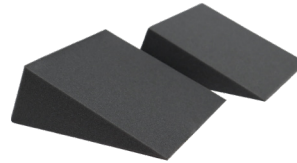

**INF-105**

Wedge - 18.75°  
3.75" H x 9" W x 8" L

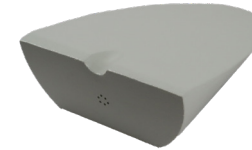

**INF-9009**

Tilt Wedge



**INF-141-SCB**

9" H x 9" W x 30" L  
Spinal Wedge 45° Scancoat®

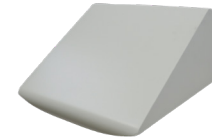

**INF-9017**

Knee Wedge



**INF-144-SCB**

7" H x 7" W x 14" L  
Spinal Wedge 45° Scancoat®



**INF-117**

Wedge - 16°  
2.5" H x 7" W x 10" L

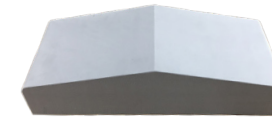

**INF-33210**

Stress Knee Wedge



**INF-144-UF**

7" H x 7" W x 14" L  
Spinal Wedge 45° UltraFoam



**INF-145-UF**

7" H x 7" W x 21.5" L  
Spinal Wedge 45° UltraFoam



**INF-113-SCB**

Wedge - 12° with ScanCoat®



**INF-215**

Endovaginal Wedge



**INF-145-SCB**

7" H x 7" W x 21.5" L  
Spinal Wedge 45° Scancoat®



**INF-145-20**

7" H x 7" W x 21.5" L  
Spinal Wedge 45°  
with Heavy Duty Vinyl Cover



**INF-114-SCB**

Rectangle with ScanCoat®

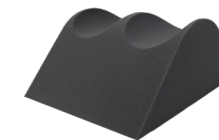

**INF-193**

Leg Rest with  
Knee Cutouts



**INF-145-8**

7" H x 7" W x 21.5" L  
Spinal Wedge 45°  
with Clear Vinyl Cover

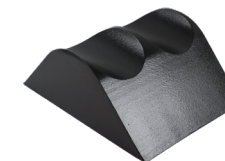

**INF-193-SCB**

ScanCoat® Leg Rest  
with Knee Cutouts

## Hand and Finger Positioning

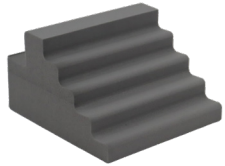

**INF-121**

Oblique Finger Block

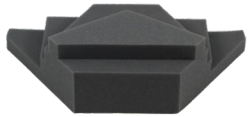

**INF-431**

Dual Lateral Finger Block

## Arm Positioning



**INF-261**

Rest Eazy Armboard GE

**INF-262**

Rest Eazy Armboard Siemens & Philips



**INF-263**

Rest Eazy Armboard Canon 850B

**INF-265**

Rest Eazy Armboard Canon 880B



**INF-9406**

Infinix Table Arm Support

## Imaging Kits

### Routine X-Ray Kit

10-piece foam positioning aids commonly used in a variety of imaging applications including general positioning, CT scans, MRI, nuclear medicine or ultrasound

**INF-17**

Routine X-Ray Kit

### Open Cell Foam

Uncovered standard foam, charcoal colored, open cell foam, radiolucent, fire retardant, economic and useful for general positioning.

**INF-17-SCB**

Scancoat® Routine X-Ray Kit

### Flexible ScanCoat

State of the art sprayed vinyl coating, withstands tearing or peeling, skid resistant, resists fluid absorption and very low attenuation. This vinyl coating is ideal for imaging compatibility, cleanability, and contamination control.

**INF-17-UF**

Ultrafoam Routine X-Ray Kit

### Closed Cell Foam

Firm, closed cell foam, charcoal colored, resists fluid absorption/contamination and is fire retardant. Ultrafoam construction is ideal for firm support during positioning applications.

### Includes

- (1) 112 - circular disc
- (1) 114 - rectangle
- (2) 116 - wedges
- (2) 117 - wedges
- (1) 118 - wedge
- (1) 121 - oblique finger block
- (2) 122 - wedges

Table Pads & Covers

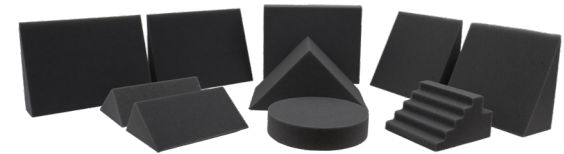

## Pediatric Immobilization

**INF-VMR33PUBB**

Pediatric Full Body Multi Chamber Splint



**INF-VMR38X01**

Child Full Body Multi-Chamber Splint



## Security and Support Items

**INF-135**

White E-Z Strap



**INF-168**

Security Strap



**INF-199**

Weight-Bearing Cassette Holder

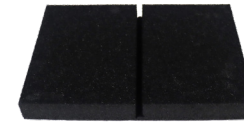

## Specialty Extensions and Extenders

**INF-27975**

Philips AD7 Bariatric Carbon  
Fiber Extension - Cardiac Table



**INF-33343**

Philips AD7 Cath Table - Foot End Extension



**INF-29632**

Philips AD7 Mayfield Carbon  
Fiber Extender - Neuro Table



**INF-33532**

Steady-Ped™ CT Foot Positioner

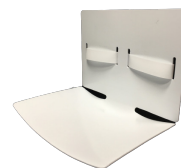

## Miscellaneous Accessories

**INF-27625**

Manual Pump



**INF-30465**

Siemens Rail



# FDA

Establishment Registration & Device Listing:  
 INFAB, LLC.  
 1040 Avenida Acaso  
 Camarillo, CA 93012  
 Registration Number: 2024351

Date of Registration Status: 2017  
 Owner/Operator:  
 INFAB, LLC.  
 1040 Avenida Acaso

Camarillo, CA 93012  
 Owner/Operator Number: 2024351  
 1040 Avenida Acaso  
 Camarillo, CA 93012  
 Phone: 805-987-5255

## FDA Certificate

Device Classification Name:	Shield, protective, personnel
510(k) Number	K896289
Device Name	RADIATION PROTECTION APRON
Applicant	INFAB, LLC. 1040 Avenida Acaso Camarillo, CA 93012
Regulation Number	892.6500
Classification Product Code	KPY
Date Received	10/31/1989
Decision Date	12/14/1989
Decision	Substantially equivalent (SE)
Classification Advisory Committee	Radiology
Review Advisory Committee	Radiology
Statement/Summary/Purged Status	Purged, no summary or statement
Type	Traditional
Reviewed by Third Party	No

## 510(k) Premarket Notification

Proprietary Name	Non leaded apron
Classification Name	Apron, non leaded
Product Code	EAJ
Device Class	1
Regulation Number	892.6500
Medical Specialty	Radiology
Registered Establishment Name	INFAB, LLC.
Registered Establishment Number	2024351
Owner/Operator	INFAB, LLC.
Owner/Operator Number	2024351
Review Advisory Committee	Radiology
Establishment Operations:	Manufacturer



## TERMS & CONDITIONS

1. **PRICING, DELIVERY AND PAYMENT.** The prices for Product delivered under this Order do not include customs charges or duties, or sales, use, excise or similar taxes, or special packaging, or transportation, rigging, drayage, insurance charges and other costs associated with the delivery of Product to the destinations specified by the Customer unless specifically set out on the invoice as individual line items. Therefore Customer will pay directly to Seller ("Seller"), in addition to the prices specified in this Order, any amount set forth on Seller's invoices for customs charges, duties and/or taxes (or provide applicable tax exemption certificates acceptable to the taxing authorities) and special packaging costs, and shall pay directly to the involved carrier(s) all such delivery related costs. All licenses or certificates required for import or export of the Product shall be the responsibility of and obtained at the cost of Customer. Seller's terms are cash upon delivery, unless otherwise set forth in a distribution or reseller agreement. If payment is by credit card, an additional fee will apply. If credit terms are approved by Seller, Customer shall pay all invoices net thirty (30) days after date of shipment. If payment is not made when due, Customer shall be assessed a late charge equal to one and one-half percent (1-1/2%) of the past due balance for each month or partial month following the due date. Additionally, at seller's discretion, all discounts shall be removed and any amounts due shall be the current list price of such items, regardless of any other agreement or discount offered. All deliveries shall be made F.O.B. common carrier, Seller's plant. Title and risk of loss or damage will transfer from Seller to Customer upon delivery of goods at the F.O.B. point. Customer shall notify Seller, in writing, within one (1) calendar day after delivery, of any claimed shortages, damage or of rejection of the delivery. Sufficient detail to establish grounds shall be included in any rejection.

2. **PRODUCT SAMPLES.** Product samples will be provided to licensed distributors of Seller's product. Upon termination of a distribution arrangement, distributor shall return to Seller, at distributor's expense, all samples previously provided to distributor by Seller in resalable as new condition. For any goods not returned in accordance with the above, Distributor will be invoiced for sample product at the same discount established for distributor for production goods. If invoice is not paid within 10 days of receipt, all discounts will be canceled and prices for samples will revert to full List Price.

3. **SECURITY INTEREST.** Seller reserves, until full payment is received, a Purchase Money Security Interest in each Product Unit and the proceeds of any sale thereof. A copy of this Order may be filed as a Financing Statement with the appropriate state authorities to perfect the security interest of Seller.

4. **CANCELLATION OF PRODUCT.** Customer hereby acknowledges and agrees that all Product is custom

manufactured for each individual Customer and once production has commenced there can be no cancellation of orders.

5. **TERMINATION.** This Order may be terminated by either party at any time: (a) if the other party has breached any material provision contained in this Order and has not cured the breach within thirty (30) days of receipt of written notice of the breach; or (b) if the other party petitions for relief under the Bankruptcy Act, if a receiver is appointed to conduct its business, if it makes an assignment for the benefit of creditors or if an involuntary bankruptcy petition is brought against it and has not been discharged within 30 days of date brought. Seller termination of this Order shall be without prejudice to any other remedies Seller may have. In the event Seller terminates this Order pursuant to Article 4, in addition to any other remedies available to Seller, Customer shall be obligated to pay for all Product shipped and shall accept delivery of and pay for all Product on order as of the date of termination. Customer's obligation to pay all charges accrued as of the termination hereof shall survive such termination.

6. **GENERAL PROVISIONS.** These terms and conditions shall supersede all terms and conditions printed or implied on any purchase order issued by Customer. No other terms or conditions shall be binding upon Customer or Seller unless said terms and conditions are specifically accepted in writing by Customer and Seller. The failure of Customer or Seller to enforce at any time or for any period of time any of the provisions of this Order shall not constitute a waiver of such provisions. Seller shall not be liable for delays or failure to ship for causes beyond Seller's control, affecting it or its suppliers, including, in part: natural disasters; war; Customer's conduct; labor unrest; riot; governmental interference; unavailability or shortage of labor, materials, fuel or power through customary means at normal rates; failure or destruction of plant or equipment arising from any cause whatsoever; or failure of transportation. If any provision of this Order should be determined to be unenforceable or illegal, it shall be deemed severable from the other provisions, which shall remain valid and enforceable. The validity, performance and construction of this Order shall be governed by the laws of the state of California. Customer agrees to accept venue in, and accept the exclusive jurisdiction of, the courts sitting in the state of California. Any disputes arising out of the performance of this Order shall be settled in accordance with the rules of the American Arbitration Association. The arbitrator may award all costs of dispute resolution, including attorneys' fees, to the prevailing party. Seller agrees that the Product to be furnished under this Order was produced in compliance with all applicable federal requirements with respect to fair labor standards and equal employment opportunity.

7. **LIMITED WARRANTY ON PRODUCT.** Seller warrants that all Products are warranted to be free of defects in

material and workmanship for a period of two (2) years from the date of shipment. This excludes glasses. Eyewear shipments in the U.S. are covered by a one (1) year warranty from date of shipment and exclusions may apply. This excludes negligence or wear and tear, including scratched or broken lenses. Inquire for additional details. Products returned under the above warranty shall be either repaired or replaced at the sole discretion of INFAB, LLC., and is limited to the value of the Products on the date of the original shipment. All replaced parts and Product become the property of Seller. This limited warranty does not include service to repair damage to the Product resulting from customer's negligence, misuse, modification of the Product, or use for purposes other than those intended by its manufacture. Does not cover excessive use or wear and tear from improper storage or customer abuse or failure to follow proper care guidelines. Warranty is voided if any solvent based cleaning solutions are used. Seller's obligations under this limited warranty are conditioned upon Customer's compliance with Seller's reasonable instructions and requests in connection with its performance of such obligations. Service under this limited warranty may be obtained by delivering the Product at Customer's expense (using the original shipping container or its equivalent) during the warranty period to the manufacturer and providing proof of purchase date. Customer shall assume the risk of loss or damage in transit. Seller shall bear the cost for return of repaired or replaced Product under valid warranty claims to Customer by normal commercial means in the continental United States. For further information, refer to the Limited Warranty contained in Seller's standard product literature, if applicable.

NOTE: All aprons must be inspected by the facility before they are put into service. No returns for aprons with alleged pinholes, tears, or cracks will be allowed more than seven (7) days after the aprons have been received by the end user. Protective core material is fragile, easily damaged and therefore great care is needed to protect the integrity of the core material. All aprons are inspected and free of defects when they are shipped. Pinholes, tears, cracks and other damage to the protective core material can be caused by many different factors, but if they are not there when the apron is received and inspected, then they are not the responsibility of the manufacturer and the warranty does not apply.

EXCEPT AS SET FORTH HEREIN AND IN THE LIMITED WARRANTY INCLUDED IN SELLER'S STANDARD PRODUCT LITERATURE, IF APPLICABLE, SELLER HEREBY DISCLAIMS ALL OTHER WARRANTIES, EXPRESS OR IMPLIED, ARISING OUT OF OR IN CONNECTION WITH THE SALE OR USE OF THE EQUIPMENT, INCLUDING, BUT NOT LIMITED TO, THE IMPLIED WARRANTIES OF MERCHANTABILITY AND FITNESS FOR A PARTICULAR PURPOSE. OTHER THAN AS STATED ABOVE THE LIMITED WARRANTY

SET FORTH IN THIS SECTION, COMBINED WITH THE LIMITED WARRANTIES CONTAINED IN SELLER'S STANDARD PRODUCT LITERATURE, IF APPLICABLE, SHALL CONSTITUTE THE SOLE AND EXCLUSIVE REMEDY OF CUSTOMER AND SHALL ESTABLISH THE SOLE AND EXCLUSIVE LIABILITY OF SELLER, ITS SUCCESSORS OR ASSIGNS IN CONNECTION WITH THE PRODUCT. IN NO EVENT WILL SELLER BE LIABLE TO CUSTOMER FOR ANY DAMAGES, INCLUDING SPECIAL, INCIDENTAL OR CONSEQUENTIAL DAMAGES, ARISING OUT OF THE USE OR INABILITY TO USE SUCH PRODUCT, EVEN IF SELLER HAS BEEN ADVISED OF THE POSSIBILITY OF SUCH DAMAGES, OR ANY CLAIM BY ANY OTHER PARTY. SOME STATES DO NOT ALLOW THE LIMITATION OR EXCLUSION OF IMPLIED WARRANTIES OR OF LIABILITY FOR SPECIAL OR CONSEQUENTIAL DAMAGES, SO THE ABOVE LIMITATION OR EXCLUSION MAY NOT APPLY TO YOU. SOME STATES DO NOT ALLOW THE LIMITATION OF LIABILITY OR THE EXCLUSION OF IMPLIED WARRANTIES, SO THE ABOVE LIMITATIONS AND EXCLUSIONS MAY NOT APPLY AND CUSTOMER MAY ALSO HAVE OTHER RIGHTS WHICH VARY FROM STATE TO STATE.

8. **DAMAGE IN SHIPMENT.** The packaging of INFAB products meets or exceeds all requirements of the Consolidated Freight Classifications. However, all packages should be checked immediately upon arrival at Customer's facility. Should any concealed damage be suspected, the Customer shall note it on the Bill of Lading when received. If any concealed damage is discovered, contact the carrier to schedule an inspection. Any claim must be made directly to the carrier as soon as possible or the claim may not be allowed. Any claim for damage must be made directly with the carrier. INFAB cannot file a claim in the name of or for the benefit of the Customer. Failure to follow this exact procedure could invalidate your claim.

9. **DELIVERY.** All stock items are shipped from our warehouse the same day if P.O. is received before noon. Otherwise it will ship next day. Non-stock or custom items (such as modified or special size aprons and/or monogramming) are shipped within 7 to 10 days of our receipt of your completed order. All special services such as UPS Blue or Red, Fed-Ex, Airborne, etc. can be accommodated at actual cost.

10. **MINIMUM ORDERS.** There is a \$100.00 minimum per purchase order.

11. **EXCHANGES OR RETURNS.** Must have prior approval by notifying us within 5 days of receipt of the order whether shipped direct to you or drop shipped to your customer. All returns must be sent in their original packaging. A 20% restock charge plus all freight charges including the outbound and return freight will be due and payable. Made-to-order items such as aprons and protection garment accessories, or a product with any modification are not returnable. This includes barriers or racks in any other color except our standard Medical White.



# View the New Infabcorp.com

Effortless Navigation, Enhanced Experience

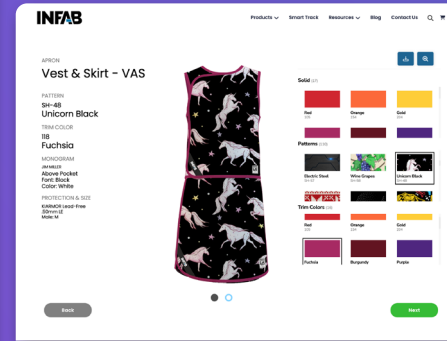
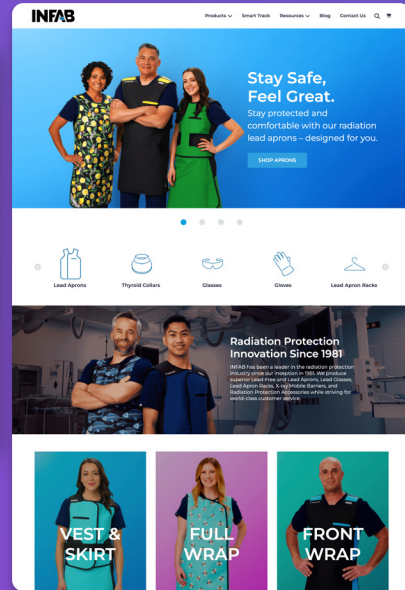
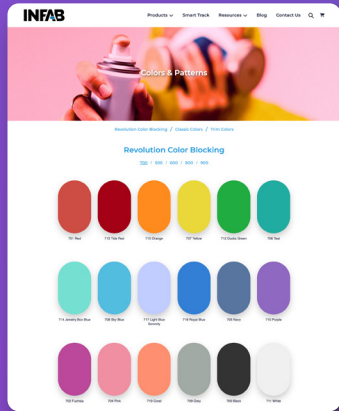

- Buyers Guides
- Resources
- Catalogs
- Blog
- Datasheets
- Certifications

## Explore the New Custom Apron Configurator

- Easy-to-use interface
- Real-time customization
- Wide range of colors & patterns
- *Add logos & monograms*

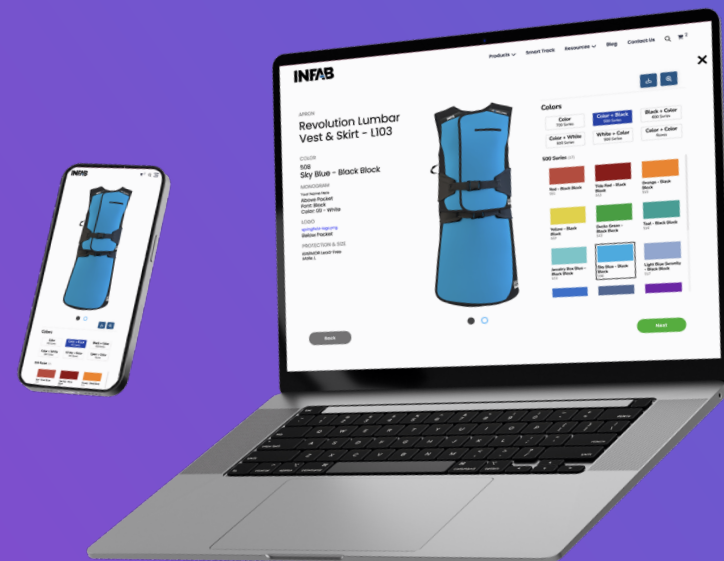

# INFAB

For Those Who Never Stop.



[infabcorp.com](https://infabcorp.com) | 805-987-5255

1040 Avenida Acaso, Camarillo, CA 93012

© 2026 INFAB, LLC. Made in USA